

ANIMO

COMBI-LINE

CN40e

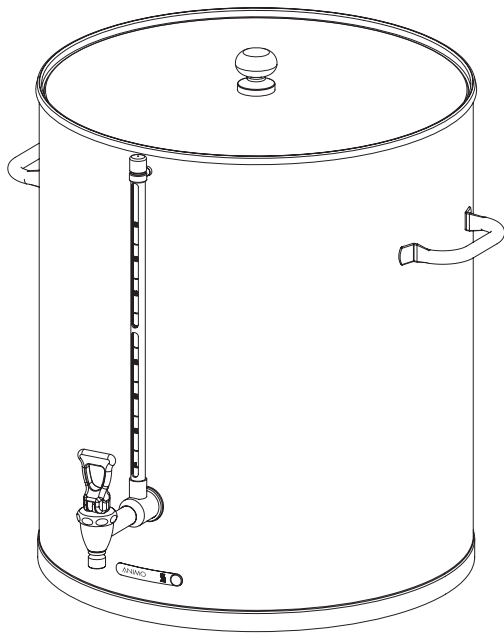

gebruiksaanwijzing
user manual
betriebsanleitung
mode d'emploi

Nederlands	3
English	13
Deutsch	23
Français	33

TABLE OF CONTENTS

	Preface	14
	Introduction	15
	Safety instructions and danger warnings	16
	Appliance and the environment	16
1.	GENERAL DESCRIPTION	17
2.	TECHNICAL DETAILS	18
3.	INSTALLATION	18
	3.1 Placing the container	18
	3.2 Connecting to the electrical supply system	18
4.	PREPARATION BEFORE USE	19
5.	USE	19
	5.1 Brewing coffee	19
	5.2 Brewing tea	20
6.	MAINTENANCE	20
	6.1 Cleaning	20
	6.2 Cleaning daily	21
	6.3 Cleaning weekly	21
	6.3.1 Cleaning the tap (Fig. 5)	21
	6.3.2 Cleaning the gauge glass (Fig. 5)	21
7.	CONSUMER ARTICLES AND ACCESSORIES	22

© 2006 Animo®

All rights reserved.

No part of this document may be reproduced and/or publized by means of printing, microfilm, electronic or any other means whatsoever without the prior written permission of the manufacturer. This also applies to the accompanying drawings and/or diagrams.

Animo reserves the right to change parts at any time without giving prior or direct notification to the customer. The content of this manual can also be changed without prior notification.

This manual covers the standard model of the appliance. Animo can therefore not be held liable for any losses arising from the fact that the specifications of the appliance supplied to you deviate from the standard model. Please contact your supplier's service department for information concerning adjustment, maintenance or repairs not covered by this manual.

Although this manual was produced with the greatest possible care, the manufacturer is unable to accept liability for errors in this document or their consequences.

You are advised to carefully read the instructions in this document: they contain important information about safety when installing, using and maintaining the appliance. Keep this document in a safe place so that you can consult it when necessary.

PREFACE

Purpose of this document

This document serves as a manual that enables qualified personnel to safely install and maintain the appliance.

All of the chapters and paragraphs are numbered. The various illustrations to which the text refers are given under the particular subjects.

Icons and symbols



NOTICE

General instructions for: IMPORTANT, NOTE or REMARK.



CAUTION!

Warning of possible damage to the appliance, the surroundings or the environment.



WARNING

Warning of possible serious damage to the appliance or physical injury.



WARNING

Warning of electricity hazard.

Introduction

Congratulations on your purchase of one of our products. We hope that you will enjoy using it.

Models

This manual covers the following container:

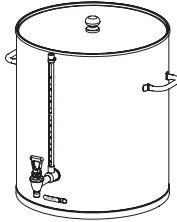

CN40e

Purpose of the appliance

This appliance can only be used for keeping hot and/or cold beverages at the right temperature and for the distribution of these beverages. The manufacturer cannot be held liable for losses caused by using the appliance for purposes other than those indicated here or by incorrect use.

Service and technical support

Please contact your dealer for information not given in this document regarding specific adjustment, maintenance and repairs. Before contacting your dealer you should note the following appliance details, marked with a #. You will find these details on the type plate attached to your appliance.

- A - Type #
- B - Article number #
- C - Machine number #
- D - Supply voltage
- E - Frequency
- F - Output

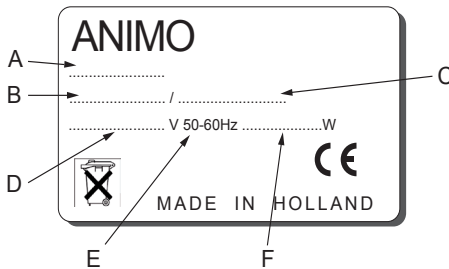

Guarantee conditions

The guarantee conditions applicable to this appliance form an integral part of the general terms of delivery.

Directives

This appliance meets the requirements of the EMC Directive 89/336/EEC and the Low Voltage Directive 72/23/EEC.

Safety instructions and danger warnings

This appliance meets the mandatory safety regulations. Inexpert use can result in personal injury and material damage. The following warnings and safety instructions must be observed before using the coffee maker.

Instructions for use

Read these instructions for use carefully, before using this appliance. This will protect your safety and prevent damage being caused to the appliance. Perform the various actions in the order given. Always keep this manual close by the appliance.

Installation

- Place the appliance at buffet height and on a firm, level base, in such a way that it can be connected to the power supply (only CNe).
- Position the appliance in such a way that no damage can be caused if it leaks.
- Connect the appliance to an earthed wall socket (only CNe).
- When installing the appliance, always observe the local rules and use approved materials and parts.
- The Installation chapter must again be followed when repositioning the appliance.

Use

- Inspect the appliance before using it and check it for damage.
- Never submerge or spray the appliance (only CNe).
- During use some parts will become very hot.
- Do not position the container on open fire, or hot plate.
- First disconnect the electric cable before transporting the container (only CNe).

Maintenance and troubleshooting

- Do not leave the appliance unattended when maintenance is being performed.
- Have all repairs carried out by a qualified technician.
- The plug must be taken out of the socket if the appliance has to be opened for cleaning or repairs (only CNe).

The manufacturer cannot be held liable for losses caused as a result of failure to observe these safety instructions.

Appliances and the environment

The packing material

Your new coffee maker has been carefully packaged to protect it against damage.

The packing is not harmful to the environment and consists of the following materials:

- Corrugated cardboard.
 - Filler elements made of polyurethane foam <PUR> covered with a polythene film (>PE-HD<).
- The waste processing plant in your municipality will be pleased to inform you where you can dispose of the materials.

Discarding the appliance

No appliance lasts forever. When the time comes to discard your appliance it will usually be possible to return it to your dealer. If this is not the case, ask your municipal council about the alternatives for recycling the materials. All plastic parts have been given standard codes. The parts of the appliance such as the printed circuit board and accompanying parts form electrical and electronic waste. The metal body is made of stainless steel and can be completely dismantled.

1. GENERAL DESCRIPTION

Animo containers are characterised by their user convenience and smart design and finish. They are made of CrNi 18/9 stainless steel and seamlessly welded. This makes them very hygienic and also easy to clean. The container is equipped as standard with an gauge glass, no-drip tap and an insulated lid for transportation. When preparing coffee and tea, having the beverage at the right temperature is crucial. The electrically heated containers guarantee optimum temperature control for coffee and/or tea, ensuring that the flavour remains good and fresh. There is also little heat transfer; the container does not become hot on the outside.

Figure 1 indicates the main components:

- A. Insulated lid
- B. Blender / transport disk
- C. Handle
- D. Gauge glass
- E. Coffee tap with "Click-it" connection
- F. Pilot light
- G. Magnet (container detection ComBi-line)
- H. Electric cable
- I. Socket with splash protection

The container is supplied with the following accessories:

- Insulated lid
- Blender / transport disk
- Electric cable 1.5 m
- Gauge glass brush
- Sticker coffee/tea (4-languages)
- This Manual

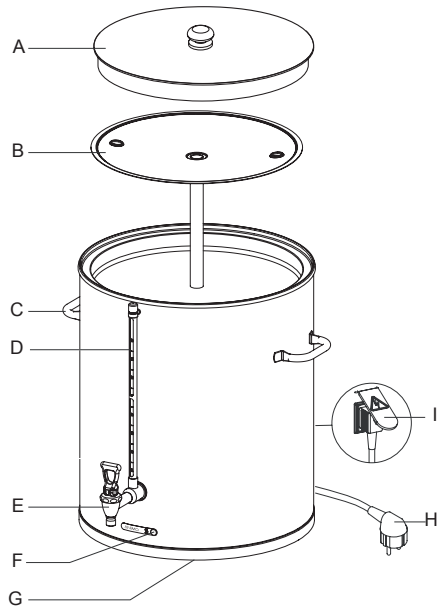

Fig. 1

2. TECHNICAL DETAILS

Electrical model	CN40e
Article number	51140
Electrical connection	1N~ 220-240V
Frequency	50-60 Cy
Power	140W
Weight empty	19 kg
Weight filled	63 kg

Weight = incl. lid/blender excl. filter.

General

Capacity	40 litre (320 cups)
Max. Capacity	44 litre
Tap outflow height	95 mm
Dimensions mm Ø	454 mm
Height incl. lid	561 mm
Height incl. filter	740 mm

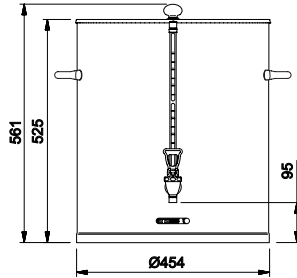

Technical modifications reserved.

WARNING

- Never submerge or spray the appliance.
- Have all repairs carried out by a qualified technician.
- Protect the controls against dirt and grease.
- During use some parts will become very hot.
- Do not position the container on open fire or on a hotplate.
- First disconnect the electric cable before transporting the container.
- It is advisable to take the plug out of the socket.

3. INSTALLATION

This appliance may only be positioned and connected by a qualified service engineer.

3.1 Placing the container

- Position the container on a counter which has a firm and even surface.
- When the container is positioned on a serving trolley, the container must initial be fixed with Animo locating lug or lock-ring.

3.2 Connecting to the electrical supply system

Supply voltages and frequencies can differ between countries. Check if the appliance is suitable for connection to the local power mains. Check if the details on the type plate correspond. Connect the appliance to an earthed wall socket.

4. PREPARATIONS BEFORE USE

The following actions should be carried out before a new appliance is used.

1. Rinse the inner pot with a clean wet cloth.
2. Put the cable with inlet plug into the back of the container and insert the plug into the socket of the flow water heater.
3. The container is now ready for use.

5. USE

5.1 Brewing coffee

A basket filter is needed to brew coffee in the container.

A flow water heater / water boiler is needed to brew coffee in the container.

Figure 2

- A - Filter lid with water distributor
- B - Basket filter paper
- C - Stainless steel inlay
- D - Basket filter
- E - Blender
- F - Container and lid

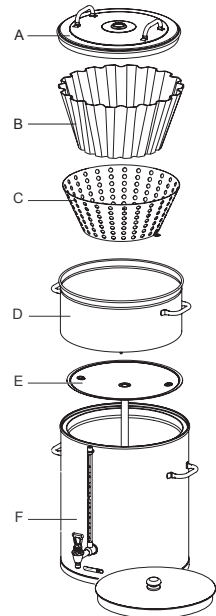

Fig. 2

1. The inner pot of the container must always be clean.
2. To avoid temperature loss during the brewing process we recommend you to pre-heat the container, by putting the cable into the socket (CNe), filling the container with approx. 2 litres of hot water and switching the container on for at least 10 minutes before the brew starts.
3. Place a basket filter paper into the combi-filter with the appropriate amount of coffee (normal/medium ground). The coffee must be evenly spread over the filter. Generally speaking you will need about 45-50 grams per litre.
4. Tap the water from the container.
5. Place the coffee blender into the container.
6. Place the filter lid on the filter, put the basket filter on the container and position the swivel arm over the centre of the lid.
7. Select the required quantity and let the flow water heater (CB) start.
8. The brewing process is starting, the blender in the container guarantees a uniform quality of the coffee, which makes decanting the coffee (with loss of time, temperature and aroma) unnecessary. The coffee is kept at a temperature of 80°-85°C. The storage time of the coffee is determined by the blend of coffee and is usually 1 to 1,5 hours.
9. After the coffee has been made and the filter has drained, the latter can be removed and the lid can be placed on the container.
10. Rinse the basket filter after use.

Attention! Always place the blender / transport disc and the lid when transporting the container by hand or serving trolley. This prevents spilling from the container.

5.2 Brewing tea

For the preparation of tea you can follow the same steps as the ones described for the coffee brewing process. However, instead of using a coffee making unit, you should use a tea filter and disk (optional).

Figure 3

- A - Filling pipe
- B - Tea filter with disk
- C - Container with lid

1. Put the tea, loose or in bags, in the tea filter, approx. 6 grams per liter.
2. Insert the tea filter into the disk (fig. 3B) already placed in the container.
3. Place the filling pipe (fig. 3A) on the tea filter. Then position the swivel arm over the pipe.
4. Select the brewing quantity and start the brewing process.
5. Remove the pipe and the tea filter after the tea has been made. **ATTENTION: the filling pipe and filter are HOT!**
6. After brewing put the insulated lid on the container to avoid loss of temperature and taste.
7. Clean the tea filter immediately after use.

Tip:

- The optimum extraction time is minimally 4 minutes and maximally 15 minutes. After more than 15 minutes the flavor of the tea deteriorates.

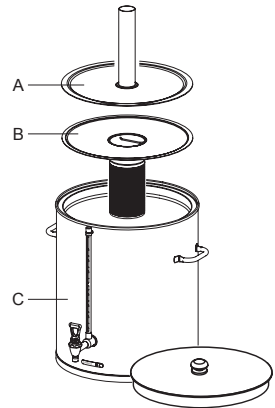

Fig. 3

WARNING

- Do not leave the appliance unattended when maintenance is being performed.
- Never submerge or spray the appliance.
- The plug must be taken out of the socket if the appliance has to be opened for cleaning or repairs.
- Always follow the manufacturer instructions when using the scale remover.

6. MAINTENANCE

6.1 Cleaning

- The outside of the container can be cleaned with a wet cloth, then wiped dry. Never use any abrasives, as these can cause scratches and dull spots.
- Always take the connection lead out of the multiple socket during cleaning and maintenance activities and close it off with the splash protector (fig. 4B). An opened splash protector (fig. 4A) protects the socket connection from moisture running in from above. A closed splash protector protects the multiple socket from dirt and moisture.
- Attention! Do not place the container type CNe (electrical execution) in the dish washer or sink.
- Do not leave the filter and the blender on a container which is not in use. Place the lid obliquely on the container, otherwise a stale taste may be the result.
- Always leave some clean water (2 cups) in the container. This stops the washers from drying out.

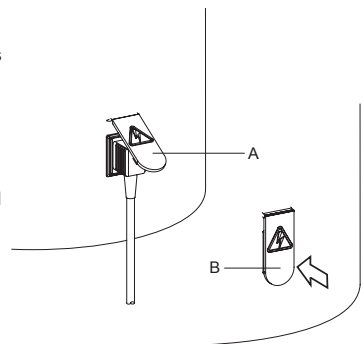

Fig. 4

6.2 Cleaning daily

- Rinse the inner pot of the container after use with hot water, or use if necessary Animo coffee fur remover. Empty the container with the no-drip tap.
- The filter, water distributor lid, blender and drip tray can be washed normally and rinsed clean. The filter and water distributor lid are allowed to be cleaned in the dishwasher.
- Despite daily cleaning coffee deposits can still remain in the inner pot and the gauge glass, see chapter 6.3.

6.3 Cleaning weekly

For the removal of the remaining coffee fur, we recommend you to use the Animo coffee fur remover (sachets). These are easy to use.

Removal of coffee deposits from the inner pot.

1. Fill half of the container with warm water and dissolve a sachet of coffee fur remover in it.
2. Let the solution work for 15 to 30 minutes, then empty the container.
3. Rinse the container thoroughly with hot water a few times.

Removal of coffee deposits from the other parts.

1. Take a bowl filled with abt. 5 liters warm water and dissolve the coffee fur remover solvent from the sachet in it.
2. Put the parts that need to be cleaned in the bowl and soak them for 15 to 30 minutes.
3. Rinse several times with warm water. Repeat treatment if the result is insufficient.
4. Scatter coffee fur remover on very filthy spots and clean with a wet brush.

6.3.1 Cleaning the tap (Fig. 5)

1. Unscrew the top of the tap by turning it to the left.
2. Pull the silicon sealer vertically away from the screw top.
3. Put the parts to be cleaned in the solution and let it work for 15 to 30 minutes.
4. Then rinse off several times with warm water and put back together in reverse order, repeat if the results are insufficient.

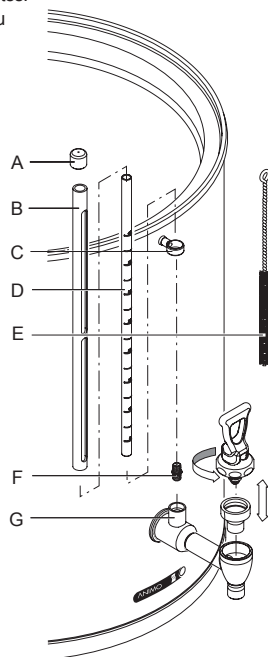

figur 5

- A - Protector cap
- B - Aluminum protector
- C - Holder
- D - Gauge glass
- E - Gauge glass brush
- F - Seal
- G - Tap connection

WARNING

- Risk of burning! Empty the container before you remove the gauge glass for cleaning.
- Always treat the gauge glass with the necessary caution. Take out the glass with the help of a dry cloth and hold the gauge glass firmly with the cloth as you clean it with the gauge glass brush.







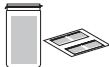

6.3.2 Cleaning the gauge glass (Fig. 5)

1. Empty the container, remove the filter and the coffee blender.
2. Take the aluminium protector (fig. 5B) off by pulling it vertically up from the gauge glass out of the holder (fig. 5C).
3. Take a dry cloth, and use it to pull the gauge glass carefully vertically out the tap connection (fig. 5G)
4. Remove the seal (fig. 5F) from the gauge glass and clean the gauge glass with the help of the supplied gauge glass brush (fig. 5E). (careful fragile!)
5. Moisten the gauge glass end + seal and put the seal back in the glass. Push the gauge glass (Seal downwards) into the tap connection (fig. 5G).
6. Place the aluminium protector (fig. 5B) vertically back again over the gauge glass.

7. CONSUMER ARTICLES AND ACCESSORIES

See the list below for the consumer articles and accessories available for the appliance. You can order these parts at your dealer, stating the details of the appliance given on the type plate, a description of the item, article number and quantity.

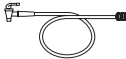
Consumer articles and accessories

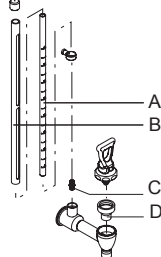
	Description		Art.No.
	Coffee fur remover	per box (100 sachets of 10 gram) per can of 1Kg	49009 00008
	Scale remover	per box (48 sachets of 50 gram) per can of 1Kg	49007 00009
	Combi filter	Container CN40e	95008
	Coffee blender	Container CN40e	96006
	Basket filter paper	280/635 - container CN40e	01131
	Tea filter with disk	Container CN40e	57007
	Filling pipe	Container CN40e	17004
	S-swivelarm	With "Click it" connection for use on no-drip tap ComBi-line.	99497
	Container tube		99499
	Gauge glass brush		08094
	A - Gauge glass 40 litre		54189
	B - Aluminum protector		54184
	C - Tulle		04279
	D - Seat cup		04034
	Cable + plug 1,5m		03072
	Cable + plug 0,6m		03071

ANIMO

Animo B.V.
Dr. A. F. Philipsweg 47
P.O. Box 71
9400 AB Assen
The Netherlands

Tel: +31 (0) 592 376376
Fax: +31 (0) 592 341751
E-mail: info@animo.nl

www.animo.eu

