

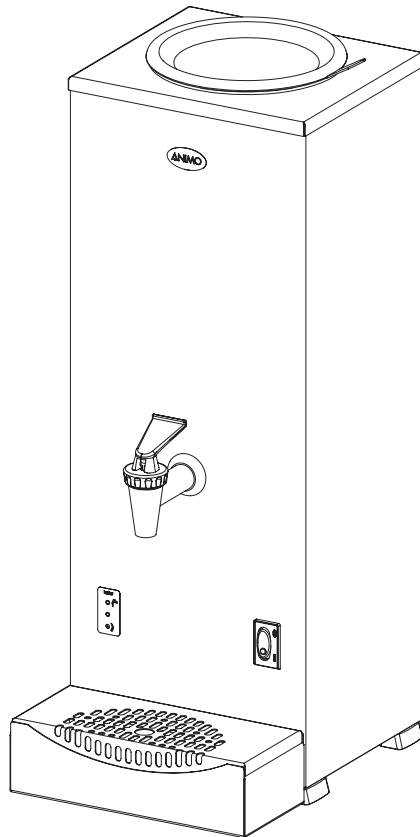



ANIMO

WKT n

5 HA
5 VA



gebruiksaanwijzing
user manual
betriebsanleitung
mode d'emploi

Nederlands	3	
Englisch	12	
Deutsch.....	21	
Français	30	



Dit apparaat voldoet aan,
 This appliance is in accordanc with,
 Dieses Geräte wurde in Übereinstimmung gemäß,
 Cet appareil est conforme à la directive:

- 2004/108/EC (EMC)
- 2006/95/EC (Low voltage)
- 2011/65/EU (RoHS)
- 2012/19/EU (WEEE)

Animo behoudt zich het recht voor om onderdelen op elk gewenst moment te wijzigen, zonder voorafgaande of directe kennisgeving aan de afnemer. De inhoud van deze handleiding kan eveneens gewijzigd worden zonder voorafgaande waarschuwing. Deze handleiding is geldig voor de machine in standaarduitvoering. Animo kan derhalve niet aansprakelijk worden gesteld voor eventuele schade voortvloeiende uit van de standaard uitvoering afwijkende specificaties van de aan u geleverde machine. Voor informatie betreffende afstelling, onderhoudswerkzaamheden of reparaties waarin deze handleiding niet voorziet, wordt u verzocht contact op te nemen met de technische dienst van uw leverancier. Deze handleiding is met alle mogelijke zorg samengesteld, maar Animo kan geen verantwoording op zich nemen voor eventuele fouten in dit boek of de gevolgen daarvan.

Animo has the right to change parts of the machine at any time without preceding or direct announcements to the client. The contents of this manual can also be changed without any announcements. This manual is to be used for the standard model/type of the machine. Thus Animo cannot be held responsible for any damage resulting from the application of this manual to the version delivered to you. For extra information on adjustments, maintenance and repair, contact the technical department of your supplier. This manual has been written very carefully. However, Animo cannot be held responsible neither for mistakes in the book nor for their consequences.

Animo behält sich das Recht vor, Einzelteile ohne vorherige Bekanntgabe an den Kunden zu ändern. Der Inhalt dieser Anleitung kann ebenfalls ohne vorherige Bekanntgabe geändert werden. Diese Anleitung gilt für die Standardausführung der Maschine. Animo haftet daher nicht für Informationen über Einstellungen, Wartungsarbeiten oder Reparaturen, die nicht in dieser Anleitung enthalten sind. Wenden Sie sich bitte an den Kundendienst Ihres Händlers. Diese Anleitung wurde mit größtmöglicher Sorgfalt hergestellt. Animo haftet jedoch nicht für etwaige Fehler in dieser Anleitung oder für die Folgen solcher Fehler.

Animo se réserve le droit de modifier les pièces à n'importe quel instant, sans avis préalable et sans obligation de notification au client. Le contenu de ce manuel est également sujet à modification sans avis préalable. Ce manuel s'applique au modèle standard de la machine. Par conséquent, Animo n'est pas responsable pour les dommages éventuels découlant de l'application de ce manuel aux modèles non standard. Pour les renseignements sur certains réglages, les travaux d'entretien ou réparations qui ne seraient pas traités dans ce manuel, Animo ne peut être tenu responsable des erreurs éventuelles ni des dommages qui en découleraient.

TABLE OF CONTENTS

1.	GENERAL	13
2.	TECHNICAL DESCRIPTIONS	14
3.	INSTALLATION	15
3.1	Positioning the appliance	15
3.2	Connection to the water supply system (model VA)	15
3.3	Connection to the electricity supply system	15
4.	CONTROLS	16
5.	FIRST TIME USE	17
6.	NORMAL USE	18
6.1	The water heater in use (model HA)	18
6.2	The water heater in use (model VA)	18
7.	Maintenance	19
7.1	Descaling	19
8.	TEMPERATURE PROTECTION	20
9.	TRANSPORT	20

This instruction is meant for users of the Animo water heater, type WKT 5n HA / VA.
Read this instruction carefully as it will ensure proper and safe use of the machine.

1. GENERAL

The water heater WKT 5n can be installed wherever large volumes of hot water are needed. The water heaters can fill both cups and small jugs. The storage water heaters are fitted with a no-drip tap fitted which makes them for this purpose easy to operate. The WKT 5n can be equipped with either manual filling (HA) or a fixed water connection (VA) for extra convenience.

In fig. 1 the main parts are indicated:

1. Indicator light
2. Hot water no-drip tap
3. Storage water heater
4. On/off switch
5. Drip tray RVS
6. Dry-boil safety protection
7. Electrical supply
8. Water connection (model VA)

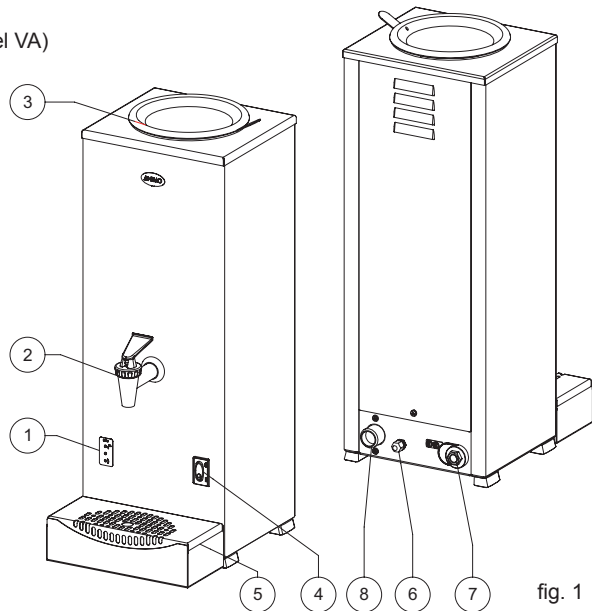

fig. 1

The machine is supplied with the following accessories:

- Lid
- Drip tray RVS
- Water supply hose 1.5m (model VA)
- 1 sachet scale remover
- This manual

2. TECHNICAL DESCRIPTIONS

Model	WKT 5n HA	WKT 5n VA
Article number	1003699	1004095
Buffer stock	4.0 ltr./ 32 cups	4.0 ltr./ 32 cups
Hour capacity	21 ltr./168 cups	21 ltr./168 cups
Heat-up time	approx. 14 min.	approx. 14 min.
Recovery time after 4 ltr.	approx. 11 min.	approx. 11 min.
Electrical connection *	1N~ 220-240 V	1N~ 220-240 V
Frequency	50-60 Cy	50-60 Cy
Power*	2100 W	2100 W
Weight empty	6.3 kg	6.6 kg
Weight filled	11.3 kg	11.6 kg

Water system (model VA)

Water connection	-	3/4" outer tread
Min. water pressure	-	0.02 MPa (0.2 bar)
Max. water pressure	-	1 MPa (10 bar)

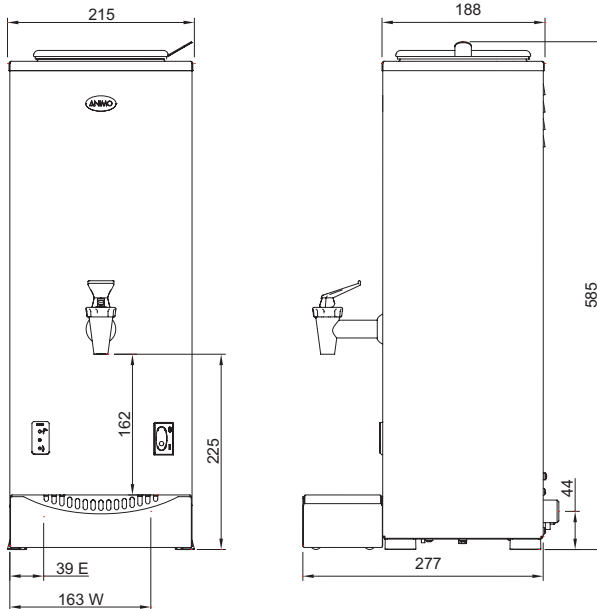

Technical alterations reserved

WARNING 

- Always remove the plug from the socket if the machine has to be opened for repair or maintenance.
- Do not position the machine in areas where the temperature drops below freezing point because there is always water left in the system.
- Always plug the machine into an earthed wall socket.
- Do not submerge or spray the machine.
- Have all repairs carried out by a specially trained technician.
- During use, some parts will become very hot.
- In case the machine is not used for a relatively long period of time, it is advisable to remove the plug from the socket and to close the water drain* (*model VA).

3. INSTALLATION

Follow the instructions to place and connect the machine, specified below.

3.1 Positioning the appliance

Place the unit:

- At counter level and on a solid flat surface.
- Where it can be connected to the electricity grid.
- In a way that it is not causing any damage in case of leakage.

3.2 Connection to the water supply system (model VA)

- The WKT 5nhh VA requires a water stop valve near the machine.
- Connect the provided water hose between the cold water supply and the water connection on the back of the unit. The hose has a length of 1.5 m.

3.3 Connection to the electricity supply system

Depending on the model, the appliance should be connected according to the instructions in (fig. 2).

- For 240V 1 phase with plug socket.
- For 240V 1 phase (3-core cable).

The following remarks apply to fig. 2:

- If the plug fitted on the electric cable does not fit in your socket, you have to replace it with a suitable one.
- The replaced plug should be thrown away as it can be dangerous if plugged in a socket.

The following points should be observed when wiring a new plug:

1. The green/yellow-colored wire ("EARTH") should be connected to the terminal which is either marked with the letter "E", the "earth" symbol () , colored green or green/yellow.
2. The blue-colored wire ("NEUTRAL") should be connected to the terminal which is either marked with the letter "N" or colored black.
3. The brown-colored wire ("PHASE") should be connected to the terminal which is either marked with the letter "L" or colored red.

IMPORTANT!

The 3 core main cable (fig. 2) has the following wiring code:

- Green/yellow - Earth (E) 
- Blue – Neutral (N)
- Brown – Phase (L)

fig. 2

4. CONTROLS

fig. 3

Refill indicator (fig. 3A); *Model HA*: the yellow indicator light will light up if the water boiler needs to be refilled. The heating element will turn off. The indicator light turns off when the water boiler has filled up sufficiently.

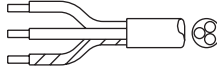
Model VA: the yellow indicator light will light up when the water boiler is automatically refilling. The heating element will turn off. The indicator light turns off when the water boiler has been filled up sufficiently.

Temperature ok indicator light (fig. 3B); The green indicator light lights up when the water boiler has reached the correct temperature. The control light turns off when the water temperature is too low.

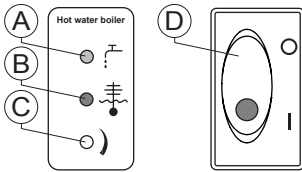
Temperature adjuster water boiler (fig. 3C); With this adjuster the water boiler temperature can be increased/reduced, using a small screwdriver.



- In high altitude areas (> 2000 meters.) the water will boil sooner because of lower atmospheric pressure. Adjust the temperature of the water boiler, so it will not boil.
- The manufacturer is unable to accept any liability for the consequences of altered settings.

On delivery the temperature of the water boiler is set at approx. 90°C.

With the adjustment point (fig. 3C) the temperature of the water boiler can be increased / reduced within a range of 84°C – 98°C. Use a small screw driver for this.

To reduce the temperature, turn left. To increase the temperature, turn right.

Power on/off switch (fig. 3D)

5. FIRST TIME USE

The following procedure should be carried out to make a new appliance ready for use.

Model HA

1. Fill the water boiler with water. Never fill up the water boiler higher than the ring indicating "MAX".
2. Switch the water boiler on using the on/off switch (fig. 3D), the indicator lights (fig. 3A&B) will lit. The water in the water heater will heat up. The green indicator light (fig. 3B) will light up the water in the boiler has reached the correct temperature.
3. Tap all of the first heated water out of the water boiler and discard it. Refill the water boiler with fresh water. Fill up the water boiler with fresh water. After this, the appliance is ready for use.

Model VA

1. Connect one side of the supported water supply hose between the swivel joint at the backside of the machine (fig. 1-10) and the other side to a manually operated water stop valve. *Be aware! Only cold water.* Open the water tap and check the connection for leaks.
2. Switch the water boiler on using the on/off switch (fig. 3D), the indicator lights (fig. 3A&B) will lit for a while. The water heater will fill automatically. After this the water will be heated up. During filling the yellow indicator light (fig. 3A) will lit. The green indicator light (fig. 3B) will be on until the water has reached the required temperature.
3. Tap all of the first heated water out of the water boiler and discard it. The water boiler will automatically be refilled with fresh water.

6. NORMAL USE

Model HA

1. Switch the water boiler on using the on/off switch (fig. 3D). The light in the switch will light up. The water in the water heater will now be heated up.
2. After approx. 14 minutes the water is heated up and the green temperature ok indicator light (fig. 3B) will light up. Hot water can now be drawn off using the no-drip tap.
3. When the yellow refill indicator light (fig. 3A) lights up, the water boiler needs to be refilled. Fill the water boiler with fresh water. *Caution* : Never fill up the water boiler higher than the ring indicating "MAX" to prevent boiling water from splashing over the pouring spout.
4. After refilling, the yellow indicator light will go out. *Caution* : when the refill indicator light is on, the heater of the water boiler will turn off. As soon as the water boiler is refilled the heater will switch on again.

Model VA

1. Switch the water boiler on using the on/off switch (fig. 3D). The light in the switch will light up. The water in the water heater will now be heated up.
2. After approx. 14 minutes the water is heated up and the green temperature ok indicator light (fig. 3B) will light up. Hot water can now be drawn off using the no-drip tap.
3. When hot water is being drawn off, the water boiler will refill automatically. During the filling the yellow refill indicator light (fig. 3A) will go on.

6.1 The water heater in use (model HA)

- Tap hot water off (a maximum of 4 liters at a time). After filling with cold water, up to the ring indicating **MAX**, it will take approx. 11 minutes before the temperature of the water boiler is restored.
- When the green temperature indicator light (fig. 3B) turns on, new hot water can be drawn off.

6.2 The water heater in use (model VA)

- Tap hot water off (a maximum of 4 liters at a time). It will take approx. 11 minutes before the temperature water heater is restored
- When the green temperature indicator light (fig. 3B) turns on, new hot water can be drawn off.

7. MAINTENANCE

- Clean the machine with a clean damp cloth.
- Avoid using abrasive. It can cause scratches and dim spots.
- Remove scale deposits by using scale remover.

WARNING

- Stay near the machine while maintenance is being carried out.
- When descaling, always follow the instructions of the scale remover used.
- It is advisable to wear safety glasses and gloves during descaling.
- Allow the machine to run through at least three times to rinse the solution from the system after it has been descaled.
- Wash your hands thoroughly after descaling
- The appliance should not be submerged or hosed off.
- Make sure all the repairs to the appliance are carried out by a qualified technician.

7.1 Descaling

During operation scale will develop in the machine. Therefore the machine needs to be descaled approx. once a month to guarantee the lowest energy consumption and proper functioning.

When to descale?

- Depending on the frequency of use and hardness of water used, we advise to inspect the unit regularly for scale formation.
 - Remove the cover of the storage water heater regularly. If there is loose scale on the bottom or if there is severe scale formation on the walls, then the unit needs to be descaled.
 - In some cases it is sufficient to only remove the loose scale.
1. Switch off the machine and remove the plug from the wall socket.
 2. Remove the cover from the storage water heater.
 3. Turn the machine upside down over the sink. The loose scale will come out.
 4. If there isn't any scale in the machine anymore, it taken into use again.
Consult section 5 "FIRST TIME USE".

To remove remaining scale use ANIMO scale remover.

5. Carefully read the caution notice and the directions on the sachet ANIMO scale remover.
6. Dissolve 1 sachets of 50 gram ANIMO scale remover into 2 liters of warm water.
7. Fill the hot water reservoir with the solution. This will now undergo a reaction with the scale deposits.
8. Allow the solution to soak in for about 10 minutes until the frothing has stopped.
9. Tap some of the acid off and pour it back into the reservoir.
10. Turn the machine upside down above the sink. Rinse the reservoir and the hot water tap, clean with hot water.
11. If there is no scale left in the machine anymore, it taken into use again. Consult section 5 "FIRST TIME USE".

8. TEMPERATURE PROTECTION

There is a temperature protection in the machine that can be accessed from the outside of the machine. This protection is located at the back of the machine (fig. 1-6). It is activated when the temperature gets too high. The most common cause for activating the security is scale that has not been removed in time.

If the temperature protection is activated, you should proceed with the following steps:

1. Let the unit cool down.
2. Unscrew the black protection cover.
3. Push the button that now appears, replace its black cover and fasten it tightly.

If the protection was triggered due to scale formation, then proceed according to section 7.1. When the scale formation was not the cause, then please contact your dealer.

9. TRANSPORT

The transport of the machine should be done as follows:

1. Switch the machine off and remove the plug from the wall socket.
2. Close the tap of the cold water supply and disconnect the water hose (VA).
3. Remove the cover of the reservoir.
4. Turn the machine upside down to let the remaining water out above the sink.
5. Place the cover again.
6. The machine is now ready for transportation.
7. Proceed with section 3 "INSTALLATION" to re-install the machine.

ANIMO

Animo B.V.
Dr. A. F. Philipsweg 47
P.O. Box 71
9400 AB Assen
The Netherlands

Tel: +31 (0) 592 376376
Fax: +31 (0) 592 341751
E-mail: info@animo.nl

www.animo.eu

