



A Crane Co. Company



Coin changer currenza

Manual
for service work

05.11 Schn/JMo/Roe
Version 2.1
HB.C2SA-EN



CRANE

National Rejectors, Inc. GmbH • Zum Fruchthof 6 • D-21614 Buxtehude
Phone: +49 (0) 41 61-729-0 • Fax: +49 (0) 41 61-729-115 • E-mail: info@nri24.com • Internet: www.nri24.com

Table of contents

1	About this manual	7
	Text conventions	7
	Additional technical documentationen	8
2	Safety instructions	9
3	Menu language	10
4	Work on the change tubes	11
	Displaying the current coin stocks in the tubes (inventory)	11
	Giving out single/several coins	12
	Giving out single coins	12
	Giving out several coins after another	13
	Emptying coin cassette	13
	Emptying all change tubes up to certain filling level (float level)	14
	Refilling change ...	15
	... by inserting coins into the changer	15
	c ² blue/white/orange	16
	c ² green	17
	... by filling the coin cassette direct ...	19
	... with non-counted coins	19
	... with counted coins (float level)	20
	Optimising coin movement in the tubes	23
	Open Coin Manager	23
	Comparing in and out of tube coins	24
	Analysing the coin movement in the tubes and set tube parameters optimally	25

5	Token configuration	26
	Teaching token in a coin channel	26
	Configuring the token taught for free vend or payment (BDV/Executive only)	28
	Configuring token values	28
	Configuring token as value token	30
	Configuring free vend token	31
	Assigning taught token to coin group A or B (option)	31
	Directing accepted tokens into return chute	33
	Erasing token configuration	34
6	Firmware update	35
	Displaying current firmware versions	35
	Updating firmware using PC & HENRI	36
	Downloading new firmware and FW update PC application from the internet	36
	Installing HenriFlash	36
	Loading new c ² firmware in HENRI	37
	Installing new firmware in the coin changer	38
	Updating firmware using SIM card & HENRI	39
7	Audit (option)	40
	Checking audit data with HENRI	40
	Which audit data is recorded and in what structure?	40
	General data	41
	Vends	41
	Flow of money	42
	Displaying audit data	45
	Reading out audit data using the IrDA interface	46
	Printing out audit data using a mobile printer	47
8	Readout of statistical data	48
	Reading out statistical data from the currenza c ²	48
	Erasing statistical data from HENRI memory	49

9	Cleaning	51
	Cleaning coin path in validation and sorting area (yearly)	51
	Cleaning payout sensor system	52
	Cleaning filling level sensor system	55
	Diagnostics	55
	Readings when optics are OK	56
	Readings when optics need to be monitored continuously	56
	Readings when optics are faulty	56
	Locating the failure cause (Golden Unit test)	57
	Cleaning in the field	57
	Cleaning coin cassette	57
	Cleaning interface module	58
	Cleaning in the workshop	60
	Disassembling coin cassette	60
	Cleaning coin cassette	62
	Reassembling coin cassette	63
10	Troubleshooting	64
	c ² status & error messages	64
	Quick diagnosis using status LEDs (only c ² green)	68
	Diagnose-Menü	70
	Displaying diagnostic menu	70
	Diagnostic screens	71
	Coin validator	71
	Interface module (changer module)	71
	Payout module	71
	Audit module/airport (option)	72
	Display/keyboard (option)	72
	Motor sensors	72
	(Filling level) sensor left (tubes A&B)/middle (tubes C&D)/right (tubes E&F)	72
11	Index	73

1 About this manual

This manual provides all information about

- displaying current tube levels/counters (inventory).
- paying out single coins or emptying/filling tubes.
- displaying change flow in the tubes.
- analysing change flow and setting tube parameters optimally depending on analysis
- teaching tokens
- updating firmware
- checking optional audit data
- reading out statistical data
- cleaning coin changer
- correcting malfunctions



This manual does not describe the whole functional range of the coin changer currenza c² or HENRI service tool. In order to be able to use the whole functional range of the devices safely as well as to configure all possible functions, all manuals for the NRI changer currenza c² and HENRI service tool must be read carefully (PDF download at www.nri24.com).

Text conventions

To make it easier for you to navigate within these instructions and to operate the devices, the following accentuations were made in the text:



Safety instructions, which you must observe in order to protect operators and equipment.



Notes, which you must observe in order to protect the environment.



Special notes, which are to facilitate the use of the devices.

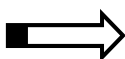

At the beginning of a chapter you will find a short "guide", which summarises the content of the chapter.

1 2 3 ... Requests to perform an action are numbered in another typeface and, if possible, listed in a table.

Service DISPLAY TEXTS are set in small capitals.



BUTTONS and **MENU ITEMS** are shown in bold capitals.

[1/2] Reference to a figure. The number before the slash refers to the figure number, the number behind the slash to the item number within the figure.

Additional technical documentationen

Apart from the manual you already have, there is further documentation for the currenza c² and HENRI service module, e.g. about technical data and configuration. All product descriptions are available as PDF format at www.nri24.com (→ Download).

2 Safety instructions



The coin changer PCBs are fitted with components that can be damaged by electrostatic discharge. Please observe the handling instructions for components exposed to the risk of electrostatic discharge.

Do not use the coin changer if the device or connecting cable are damaged.

Never pull the connecting cable of the coin changer from the machine when a voltage is applied.

Pull out the machine's mains plug before you remove or clean the coin changer.

Contact NRI if you wish to alter the construction of the device to a greater extent than that described in this manual.

If the device is no longer required, please dispose of it correctly.

We reserve the right to make technical modifications to the device which are not covered by this manual!



3 Menu language

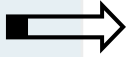

This chapter describes how to set the menu language of the coin changer:

The c² supports the following languages:









- English
- German
- Options:
 - Spanish, French, Italian
 - Dutch
 - Polish, Slovakian, Czech
 - Hungarian

and is provided with three installed languages. The third language is customised. If required, the coin changer may also be provided with other languages than listed above.

To select the menu language (also language for audit receipts):

Quick approach:

 = Main menu >  = Settings >  = Other settings >  = Language

	Press key ...	How often?	Effect
1		1 x	You enter the main menu
2		1 x	You enter the SETTING menu
3		until Other settings	You want to enter submenu OTHER SETTINGS
4		1 x	You enter the submenu
5		1 x	You want to set the menu LANGUAGE
6		1 x	Now you can set the LANGUAGE
7		until language desired	You want to set this language
8		1 x	You lock the language selected in memory
9		1 x/2 x	You return to main menu/operating mode

4 Work on the change tubes

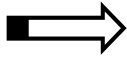

In this chapter you will learn how to

- display the current tube counters/levels (inventory)
- pay out single coins
- empty the change tubes (completely/up to a certain filling level (float level))
- fill the change tubes
- optimise the change movement in the tubes

Displaying the current coin stocks in the tubes (inventory)

To display the current total stock and the number of coins in the individual tubes:

1 Connect c² green/white/orange with HENRI service tool (plug HENRI RJ-45 connector into coin changer socket in the upper right hand corner, cp. separate HENRI short reference guide).
HENRI switches to c² mode automatically and shows the (vending machine) display in normal operating mode, e.g., the current change stock, if there is no error.

2 Press **MENU** key.
You enter the main menu:

```
A = Audit
B = Inventory
C = Service
D = Diagnostic
E = Settings
F = Filling
Back: MENU
```

3 Press **B** key.
First of all the **INVENTORY** screen displays the tube combination of the cassette installed:

```
Inventory:
[A] [F]
2.00 [C] [D] 0.50
[B] 1.00 0.10 [E]
0.05 0.20
```

After a short period of time the screen shows on the one hand the value of the whole cassette contents and on the other hand the counter of each tube:

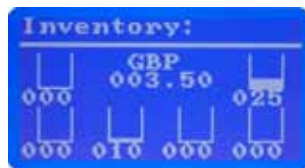

The security stock per tube possibly configured is not displayed (cp. separate configuration manual).

Pressing the inventory key **A**, **B**, **C**, **D**, **E**, or **F** briefly would now pay out single coins and holding down the key would pay out several coins one after another from the appropriate tube. The coins will stop being paid out if you press any other inventory key A–F. (Cp. next section)

4 Use **MENU** key to return to the main menu.

Giving out single/several coins

Coins can be given out either using the menu item **INVENTORY** (see section "Displaying the current coin stocks in the tubes (inventory)" in this chapter) or if you have a c² blue or green also using the inventory keys A–F direct, provided that no menu has been selected:

For testing the coin return or acceptance coins can be paid out either individually or one after another. For this the internal keys A–F apply to the tubes A–F.



If the changer is configured in such a way that the inventory keys are disabled, the keys cannot be used.

Either the device is set up in such a way that the keyboard can be enabled using the VMC (MDB and BDV VMCs only), or the keyboard must first be activated using the menu (see separate configuration manual).

Giving out single coins

To give out tube coins individually, simply press the corresponding inventory key. One coin will be given out each time the key is pressed.

Giving out several coins after another

To give out several tube coins:

- 1 Hold down the corresponding key **A–F** for approx. five seconds.
The tube gives out several coins.
- 2 Press any other key **A–F**.
The coins will stop being paid out.

Emptying coin cassette

In order to empty all change tubes completely e.g. before transport, for repairs, or in case of an inventory:

- 1 Connect c² green/white/orange with HENRI service tool (plug HENRI RJ-45 connector into coin changer socket in the upper right hand corner, cp. separate HENRI short reference guide).
HENRI switches to c² mode automatically and shows the (vending machine) display in normal operating mode, e.g., the current change stock, if there is no error.
- 2 Press **MENU** key.
You enter the main menu:



- 3 Press **C** key to open the SERVICE menu:



- 4 Press **OK** key to empty all tubes of the cassette:

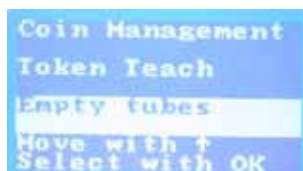

- 5 Press **OK** key to empty all tubes of the cassette.
The tube counters are reset.
- 6 Use **EXIT** key to return to the main menu.

Emptying all change tubes up to certain filling level (float level)

If a float level is configured for each change tube, the change tubes can be emptied up to the number of tube coin set in the float levels. (Cp. separate configuration manual)

To empty all change tubes up to the float level:

- 1 Connect c² green/white/orange with HENRI service tool (plug HENRI RJ-45 connector into coin changer socket in the upper right hand corner, cp. separate HENRI short reference guide).
HENRI switches to c² mode automatically and shows the (vending machine) display in normal operating mode, e.g., the current change stock, if there is no error.

- 2 • c² blue/white/orange: Press **MENU** key.
You enter the main menu:

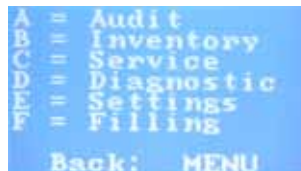

Press **F** key to activate the FILLING MODE.
First of all the display shows the tube combination of the cassette installed:

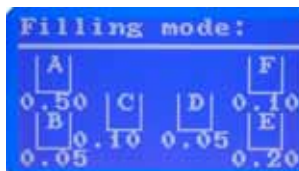

After a short period of time the screen shows on the one hand the value of the whole cassette contents and on the other hand the counter of each tube:



- c² green:

Press **+**-key.

The flashing of the green LED (c² green only) shows that the coin changer is no longer in operating mode, but in filling level mode.

- 3 Hold down the **B** key for approx. three seconds.
All tubes will automatically be emptied up to the configured float level.

Refilling change ...

The coin changer can be provided with change either by inserting the tube coins when the empty coin cassette is installed, or you remove the empty coin cassette and fill the cassette direct.

... by inserting coins into the changer



In many cases, the VMC also offers a filling function. In that case, this filling function should be used, due to the fact that the VMC may not be able to accept the filling level of the changer.

If the cash-box is not empty, it must be emptied now, because the coins directed to the cash-box will not be counted.



The cash-box does not need to be emptied, if the changer has been set so that only coins to be sorted into tubes are accepted and cash-box coins are inhibited when the tubes are being filled (see separate configuration manual).

In order that the coin changer can count the inserted tube coins for audit and inventory purposes the coin changer must be filled in the tube filling mode. Activating this mode differs depending on the coin changer model:

- c² blue using menu
- c² green using keyboard
- c² white/orange using HENRI

Please read the section designated for your coin changer.



As the exact coin number is registered the automatic tube counter correction, which adapts the tube counter readings after each coin acceptance and payout to the measurements of the filling level sensors, must not be active (see separate configuration manual).



If you remove and completely empty the coin cassette before refilling it, the "automatic tube counter correction" and the "tube counter correction to zero" must be activated, so that the tube counters will be reset before the filling process.

c² blue/white/orange



1 Connect c² green/white/orange with HENRI service tool (plug HENRI RJ-45 connector into coin changer socket in the upper right hand corner, cp. separate HENRI short reference guide).
HENRI switches to c² mode automatically and shows the (vending machine) display in normal operating mode, e.g., the current change stock, if there is no error.

2 Press **MENU** key.
You enter the main menu:

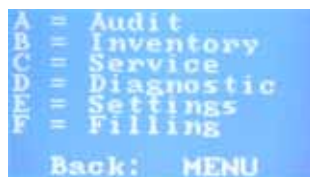

3 Press **F** key to activate the FILLING MODE.
First of all the display shows the tube combination of the cassette installed:

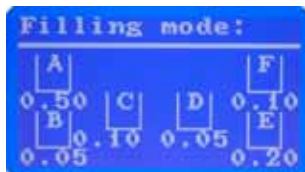

After a short period of time the screen shows on the one hand the value of the whole cassette contents and on the other hand the counter of each tube:



4 Insert coins individually.
The display shows the tube the inserted coin has been sorted to:



The corresponding tube counter counts the coins accepted. The tubes are full when the

- full sensor is covered,
- configured filling level limitation has been reached or
- configured float level has been reached.

(Cp. separate configuration manual)

Now the tube coins inserted will, depending on each setting, either no longer be accepted and directed into the return area, or they will be accepted and directed into the cash-box.

5 Use **EXIT** key to return to the main menu.



When inserting the first coin into each tube, make sure the coin lies flat inside the tube (cp. separate configuration manual, reference "security stock").

It is possible that the coin changer/HENRI displays a lower change stock in the operation mode than in the filling mode: In this case the coin changer is set so that the tube counter readings are transmitted to the VMC without security stock (see separate configuration manual).

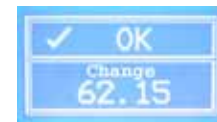

Tube filling level message without security stock

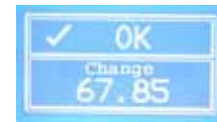

Tube filling level message with security stock

c² green



1 Press -key.

The flashing of the green LED shows that the coin changer is no longer in operating mode, but in tube filling mode.

2 Insert tube coins.

The corresponding tube counter counts the coins accepted, and the changer sorts the respective coin into its configured tube: either until the

- full sensor is covered,
- configured filling level limitation has been reached or
- configured float level has been reached.

(Cp. separate configuration manual)

Now the tube coins inserted will, depending on each setting, either no longer be accepted and directed into the return area, or they will be accepted and directed into the cash-box.



When inserting the first coin into each tube, make sure the coin lies flat inside the tube (cp. separate configuration manual, reference "security stock").

If all tubes are full:

3 Press -key again.

The green LED lighting up shows that the changer is no longer in tube filling mode, but back in operating mode.



If no coins are inserted in a 30-second time period, the changer returns to operating mode, without the -key being pressed again.

... by filling the coin cassette direct ...

You can also remove the empty coin cassette and refill it direct. Or you have filled a replacement cassette beforehand and only replace the empty cassette on site. For audit and inventory purposes either:

- the automatic tube counter correction must be active or
- the coins must be counted, this number of coins must be configured as float level per tube, the automatic tube counter programming must be active and the automatic tube counter correction must be deactivated.

(Cp. separate configuration manual)

... with non-counted coins

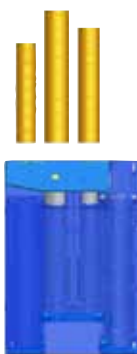

1 Remove empty coin cassette:

- Lift lever (Fig. 1, A).
- Pull cassette straight out of the housing guides to the front (Fig. 1, B).

2 If necessary, fill coin cassette.

3 Reinstall full (replacement) coin cassette:

- Insert cassette in upper and lower housing guides (Fig. 1, B).
- Push cassette into the housing.
- Press cassette down and let it engage in the upper and lower housing guides (audible click) (Fig. 1, C).



As you fill the cassette with no particular number of coins which could be counted or registered by the coin changer, the automatic tube counter correction must be active. It adapts the tube counter readings after each coin acceptance and payout to the measurements of the filling level sensors (cp. separate configuration manual).

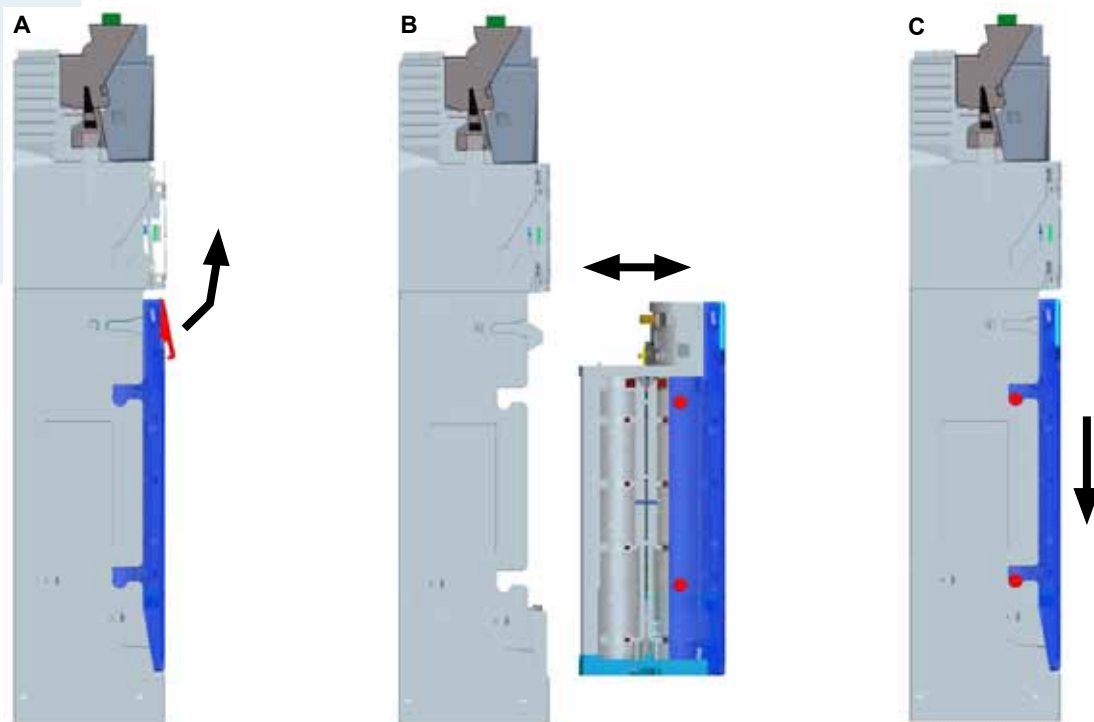

Fig. 1: Removing and reinstalling the coin cassette

... with counted coins (float level)

If the change tubes are supposed to always be filled with a certain number of coins, this number of coins (float level per tube) as well as the automatic tube counter programming must be set in the coin changer. These settings ensure for audit and inventory purposes that the tube counters are set to the float level automatically when exchanging the coin cassette.

The coin cassette must be exchanged or filled in the tube filling mode. Activating this mode differs depending on the coin changer model:

- c² blue using menu
- c² green using keyboard
- c² white/orange using HENRI

Please read the section designated for your coin changer.

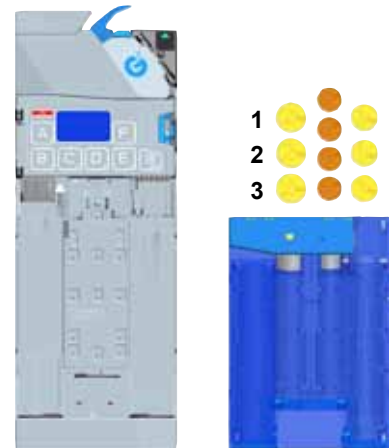

c² blue/white/orange

- 1 Connect c² green/white/orange with HENRI service tool (plug HENRI RJ-45 connector into coin changer socket in the upper right hand corner, cp. separate HENRI short reference guide).
HENRI switches to c² mode automatically and shows the (vending machine) display in normal operating mode, e.g., the current change stock, if there is no error.

- 2 Press **MENU** key.
You enter the main menu:

```

A = Audit
B = Inventory
C = Service
D = Diagnostic
E = Settings
F = Filling
Back: MENU

```

- 3 Press **F** key to activate the FILLING MODE.
First of all the display shows the tube combination of the cassette installed:

```

Filling mode:
┌ A ───┐ ┌ F ───┐
│ 0.50 │ │ 0.10 │
└──┬──┘ └──┬──┘
    │ C │ │ D │
    │ 0.10 │ │ 0.05 │
    └──┬──┘ └──┬──┘
        │ B │ │ E │
        │ 0.05 │ │ 0.20 │

```

After a short period of time the screen shows on the one hand the value of the whole cassette contents and on the other hand the counter of each tube:

```

Filling mode:
┌──┬──┐ ┌──┬──┐ ┌──┬──┐ ┌──┬──┐
│ 000 │ │ EUR │ │ 000 │ │ 000 │
│ 000 │ │ 000.00 │ │ 000 │ │ 000 │
└──┬──┘ └──┬──┘ └──┬──┘ └──┬──┘
    │ 000 │ │ 000 │ │ 000 │ │ 000 │

```

- 4 Remove empty coin cassette:
 - Lift lever (Fig. 1, A).
 - Pull cassette straight out of the housing guides to the front (Fig. 1, B).

The tube counters are set to the configured float levels, and the float levels (number of coins to be filled) are displayed.
- 5 If necessary, fill (replacement) coin cassette with number of coins set in the float level per tube.

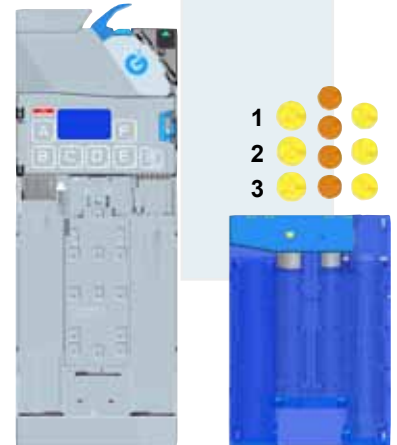

6 Reinstall full (replacement) coin cassette:

- Insert cassette in upper and lower housing guides (Fig. 1, B).
- Push cassette into the housing.
- Press cassette down and let it engage in the upper and lower housing guides (audible click) (Fig. 1, C).

7 Use **MENU** key to return to the main menu.



The automatic tube counter correction must be deactivated so that the accurately set tube counters will not be corrected according to the filling level sensors.

It is possible that the changer/HENRI displays less change available in the operating mode than in the filling mode: In this case the coin changer is set so that the tube counter readings are transmitted to the VMC without security stock (see separate configuration manual).

c² green

1 Press -key.

The flashing of the green LED shows that the coin changer is no longer in operating mode, but in tube filling mode.

2 Remove empty coin cassette:

- Lift lever (Fig. 1, A).
- Pull cassette straight out of the housing guides to the front (Fig. 1, B).
The tube counters are set to the configured float level.

3 If necessary, fill coin cassette.

4 Reinstall full (replacement) coin cassette:

- Insert cassette in upper and lower housing guides (Fig. 1, B).
- Push cassette into the housing.
- Press cassette down and let it engage in the upper and lower housing guides (audible click) (Fig. 1, C).

5 Press -key again.

The green LED lighting up shows that the changer is no longer in tube filling mode, but back in operating mode.



The automatic tube counter correction must be deactivated so that the accurately set tube counters will not be corrected according to the filling level sensors.

It is possible that the changer reports less change than refilled: In this case the coin changer is set so that the tube counter readings are transmitted to the VMC without security stock (see separate configuration manual).

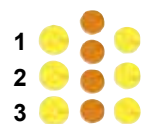

Optimising coin movement in the tubes

The coin changer currenza c² supports you in setting the tube parameters optimally, i.e. it provides analyses guaranteeing that the coin cassette not only collects as much cash as necessary but also as less as possible depending on the installation site. The c² Coin Manager places different functions at your disposal:

- Comparing in and out of tube coins
- Analysing coin movement in the tubes
- Setting tube parameters optimally

Open Coin Manager

1 Connect c² green/white/orange with HENRI service tool (plug HENRI RJ-45 connector into coin changer socket in the upper right hand corner, cp. separate HENRI short reference guide).

HENRI switches to c² mode automatically and shows the (vending machine) display in normal operating mode, e.g., the current change stock, if there is no error.

2 Press **MENU** key.

You enter the main menu:

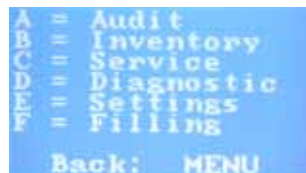

3 Press **C** key to open the SERVICE menu:



4 Press **B** key "down-arrow" to select submenu COIN MANAGEMENT.

5 Use **OK** key to confirm your selection:



You may proceed with the above-mentioned functions from this submenu:

Comparing in and out of tube coins



The required menu item PAYOUT STATISTICS has already been selected.

6 Press **OK** key to confirm your selection:

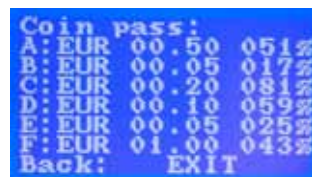

The changer/HENRI displays for each tube how many per cent of the accepted coins have been paid out.



If not enough tube coins have been accepted or paid out in order to analyse the coin movement, the display shows three question marks.

If less than 100% is displayed, more tube coins have been inserted than paid out. If more than 100% is displayed, more coins have been paid out than inserted.

7 Use **MENU** key to return to the main menu.

Analysing the coin movement in the tubes and set tube parameters optimally



6 Press **B** key "down-arrow" to select submenu STATUS OF ANALYSIS.

7 Press **OK** key to confirm your selection:

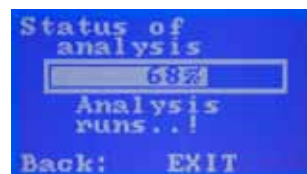

The analysis is running. If it is completed, the coin changer returns to the submenu COIN MANAGEMENT.

8 Press **B** key "down-arrow" to select submenu PROPOSALS FOR OPTIMIZATION.

9 Press **OK** key to confirm your selection:

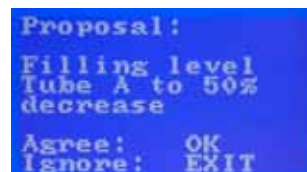

After the data has been analysed successfully, the changer could suggest FILLING LEVEL TUBE A TO 50% DECREASE.

This proposal would be submitted if the tube A coins are paid out that seldom that a change capacity of 50% is enough.

You may accept or ignore this proposal. When accepting the proposal the tube A float level is reduced from 100% or 75% to 50% automatically. The display confirms with FLOAT LEVEL ADAPTED.

10 Use **MENU** key to return to the main menu.

5 Token configuration

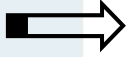

This chapter describes how to

- teach a new token in a coin channel,
- configure this token either as free vend token or as value token,
- assign a token to coin group A or B (option),
- direct accepted tokens into the return chute and
- erase a configuration

Teaching token in a coin channel

The coin changer currenza c² has three coin channels to teach up to three tokens, i.e. the measured token values generated by inserting the tokens can be assigned to a coin channel on the machine direct. The acceptance band which is created by inserting at least ten tokens of one type will accept this token for payment on the machine.

Additionally, a normal or wide acceptance band can be chosen for the configured token.



However, a wide acceptance band makes the acceptance of fraud coins more likely. Therefore a wide acceptance band should only be configured if a limited number of tokens are available to generate the token measurement values, or if the tokens show very large tolerance values. Otherwise, too many fraud coins will be accepted for payment.

To teach a new token:

- 1** Connect c² green/white/orange with HENRI service tool (plug HENRI RJ-45 connector into coin changer socket in the upper right hand corner, cp. separate HENRI short reference guide).

HENRI switches to c² mode automatically and shows the (vending machine) display in normal operating mode, e.g., the current change stock, if there is no error.

- 2** Press **MENU** key.
You enter the main menu:



- 3** Press **C** key to open the SERVICE menu:



- 4 Press **B** key "down-arrow" twice to select submenu **TOKEN TEACH**.
- 5 Use **OK** key to confirm your selection:

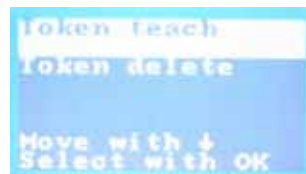

- 6 Press **OK** key again to teach a token.
- 7 If necessary, use **B** key "down-arrow"/**A** key "up-arrow" to select desired token: **TOKEN A**, **TOKEN B** or **TOKEN C**.
- 8 Use **OK** key to confirm your selection.
You are now challenged to insert at least 10 tokens of one type.
- 9 Press **OK** key after having inserted as many different tokens as possible of one type.
- 10 Use **A** or **B** key to select normal or wide acceptance band.
- 11 Use **OK** key to confirm your selection.
Now the changer/HENRI displays whether the measured values generated by inserting tokens could have been saved as an acceptance band or not:



or



The latter message is displayed if either less than 10 tokens have been inserted or the acceptance band generated overlaps at least one acceptance band of a coin channel already programmed. The process is aborted.

- 12 Use **MENU** key to return to the main menu.
- 13 Power reset the coin changer twice.
The coin changer will now accept the new token.

Configuring the token taught for free vend or payment (BDV/Executive only)

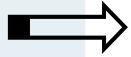

In this section you learn how to:

- configure token values
- configure free vend tokens



You do not have to configure all three tokens A, B, and C as value tokens or as free vend tokens; token A, e.g., can be free vend token and token B value token.

Whether a token is directed to the return area or into the cash-box, is customised by NRI.

Configuring token values

Taught tokens can either be configured as free vend tokens (see next section) or as value tokens.

The token value does not have to match a price. If the token value is > price, the remaining credit is not paid out. If the token value is < price, the customer must pay the difference. However, the changer will not accept more than one token for any one vending operation.



he lowest digit of a token value may only be changed in steps of the smallest coin value (cp. separate configuration manual).



If you assign a certain value to a taught token the coin order that is specified according to the ascending coin value may shift. As coins are inhibited according exactly this order in the currenza c² for the "Tube empty" message, the inhibiting information may also shift and must be adapted, if necessary (cp. separate configuration manual).

To set a token value:

- 1 Press **MENU** key.

You enter the main menu:

```
A = Audit
B = Inventory
C = Service
D = Diagnostic
E = Settings
F = Filling
Back: MENU
```

2 Press **E** key to open the SETTINGS menu:

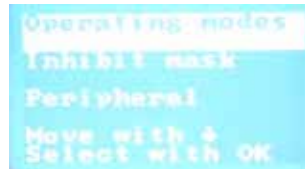

3 Press **B** key "down-arrow" until submenu COIN SETTINGS is selected.

4 Use **OK** key to confirm your selection.

5 Press **B** key "down-arrow" until submenu TOKEN is selected:

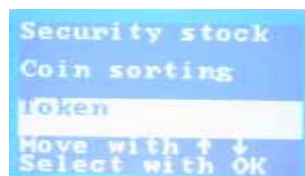

6 Use **OK** key to confirm your selection:

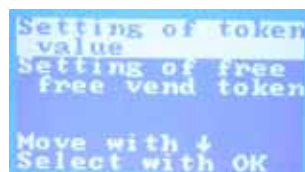

7 Press **OK** key again to open submenu SETTING OF TOKEN VALUE.

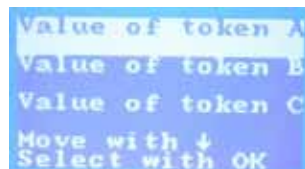

8 If necessary, use **B** key "down-arrow"/**A** key "up-arrow" to select token (TOKEN A, TOKEN B or TOKEN C) the value of which is to be set.

9 Use **OK** key to confirm your selection:

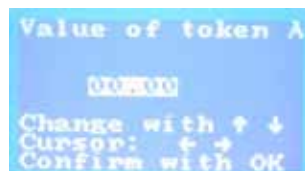

10 Set token value:

- Use **D** key (right arrow)/**C** key (left arrow) to highlight the place of the token value to be changed.
- Use **A** key (up-arrow)/**B** key (down-arrow) to configure the value of the place highlighted.

11 Use **OK** key to confirm token value.

12 Use **MENU** key to return to the main menu.

Configuring token as value token

If you configured a value for a taught token and if this token is to be cashed just as a coin with this value, you must configure the token as value token:



If the vending machine does not support any token functions, an alternative value may specify the value for a token. Actually, the alternative value defines the coin value for a second currency. Configuring an alternative coin value invalidates the real coin value. The alternative coin value is only used as token value if the vending machine cannot identify the token ID coming from the coin changer. The alternative coin value does not report a token but a coin.

- 1 Connect c² with HENRI service tool (plug HENRI RJ-45 connector into coin changer socket in the upper right hand corner, cp. separate HENRI short reference guide).
HENRI switches to c² mode automatically and shows the (vending machine) display in normal operating mode, e.g., the current change stock, if there is no error.
- 2 To configure a value token:

Quick approach:

= HENRI main menu > = Extended functions > = Channels

	Press key ...	How often?	Effect
1		1 x	You enter the HENRI main menu
2		1 x	You enter submenu EXTENDED FUNCTIONS
3		1 x	You want to access the setting table Coin CHANNELS
4		until required token/token channel	You highlight the token to be configured as value token
5		1 x	You enter the submenu with all setting options of this channel
6		until required setting option VALUE TOKEN	You highlight setting option VALUE TOKEN
7		1 x	Now you can set the value token. The current setting NOT ACTIVE is flashing
8		1 x	You configure VALUE TOKEN ACTIVE, so that the token accepted in this channel is cashed in with a value
9		1 x	Setting has been confirmed and is no longer flashing
10		2 x	You want to store the setting in the coin changer?
11		1 x	You lock the setting in the coin changer memory
12		1 x	You enter the HENRI main menu again
13		1 x/2 x	You return to the c ² operating mode/c ² main menu

- 3 Disconnect and reconnect the coin changer twice.
The new setting has also been stored in the changer interface.

Configuring free vend token

Thought tokens can either be configured as value tokens (see last section) or as free vend tokens.



For BDV and Executive changers a token value must be programmed before the corresponding token can be set as free vend token (see above).

To set a free vend token:

- 1** Follow steps 1 to 6 in section "Configuring token value".
- 2** Press **B** key "down-arrow" to select submenu SETTING OF FREE VEND TOKEN.
- 3** Press **OK** key to confirm your selection:

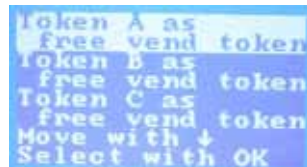

- 4** If necessary, use **B** key "down-arrow"/**A** key "up-arrow" to select token (TOKEN A, TOKEN B or TOKEN C), that is to be free vend token.
- 5** Press **OK** key to confirm your selection.
- 6** If necessary, use **B** key "down-arrow"/**A** key "up-arrow" to select setting.
- 7** Press **OK** key to confirm your selection.
- 8** Use **MENU** key to return to the main menu.

Assigning taught token to coin group A or B (option)

As an option the coins and tokens programmed in the coin changer may be assigned to two coin groups A (standard) and B using the HENRI service tool, e.g., to differentiate between two currencies (1st currency = coin group A, 2nd currency = coin group B). It is also possible to assign the coin/token to both coin groups.

The two coin groups can be selected using the switching block on the rear of the coin validator, in order that the coin changer accepts either coin group A or B (cp. separate configuration manual).

To assign a taught token to a coin group:













1 Connect c² with HENRI service tool (plug HENRI RJ-45 connector into coin changer socket in the upper right hand corner, cp. separate HENRI short reference guide).

HENRI switches to c² mode automatically and shows the (vending machine) display in normal operating mode, e.g., the current change stock, if there is no error.

2 Configuration:

Quick approach:

 = HENRI main menu >  = Extended functions >  = Channels

	Press key ...	How often?	Effect
1		1 x	You enter the HENRI main menu
2		1 x	You enter submenu EXTENDED FUNCTIONS
3		1 x	You want to access the setting table Coin CHANNELS
4		until required token/token channel	You highlight the token to be assigned to a coin group
5		1 x	You enter the submenu with all setting options of this channel
6		until required setting option ACTIVE IN A/ACTIVE IN B, depending on whether the token is to be accepted in coin group A (standard) or B	You highlight the setting option
7		1 x	Now you can select the coin group. The current setting is flashing
8		until required setting ACTIVE if the token is to be accepted in this coin group/NOT ACTIVE if it is not to be accepted	You configure e.g. ACTIVE IN B ACTIVE if the token is to be accepted in coin group B
9		1 x	Setting has been confirmed and is no longer flashing
10		2 x	You want to store the setting in the coin changer?
11		1 x	You lock the setting in the coin changer memory
12		1 x	You enter the HENRI main menu again
13		1 x/2 x	You return to the c ² operating mode/c ² main menu

3 Disconnect and reconnect the coin changer twice.

The new setting has also been stored in the changer interface.

Directing accepted tokens into return chute

Usually, tokens are directed into the cash-box. However, you may set the coin changer so that tokens, though they have been accepted and registered, will be directed back to the customer into the return chute:













1 Connect c² with HENRI service tool (plug HENRI RJ-45 connector into coin changer socket in the upper right hand corner, cp. separate HENRI short reference guide).

HENRI switches to c² mode automatically and shows the (vending machine) display in normal operating mode, e.g., the current change stock, if there is no error.

2 To redirect tokens into the return chute:

Quick approach:

 = HENRI main menu >  = Extended functions >  = Channels

...	Taste drücken	Wie oft?	Ziel
1		1 x	You enter the HENRI main menu
2		1 x	You enter submenu EXTENDED FUNCTIONS
3		1 x	You want to access the setting table Coin CHANNELS
4		until required token/token channel	You highlight the token to be directed into the return chute
5		1 x	You enter the submenu with all setting options of this channel
6		until required setting option REJECT IN A/B, depending on whether the token is accepted in coin group A (standard) or B	You highlight setting option REJECT
7		1 x	Now you can redirect the token. The current setting NOT ACTIVE is flashing
8		1 x	You configure REJECT IN A/B ACTIVE, so that the token is accepted in coin group A/B and directed into the return chute
9		1 x	Setting has been confirmed and is no longer flashing
10		2 x	You want to store the setting in the coin changer?
11		1 x	You lock the setting in the coin changer memory
12		1 x	You enter the HENRI main menu again
13		1 x/2 x	You return to the c ² operating mode/c ² main menu

3 Disconnect and reconnect the coin changer twice.

The new setting has also been stored in the changer interface.

Erasing token configuration

If a configured token is no longer to be accepted for payment, as the coin channel is to be programmed with another token you are able to erase the present token configuration:

- 1 Connect c² green/white/orange with HENRI service tool (plug HENRI RJ-45 connector into coin changer socket in the upper right hand corner, cp. separate HENRI short reference guide).
HENRI switches to c² mode automatically and shows the (vending machine) display in normal operating mode, e.g., the current change stock, if there is no error.

- 2 Press **MENU** key.
You enter the main menu:



- 3 Press **C** key to open the SERVICE menu:



- 4 Press **B** key "down-arrow" twice to select submenu TOKEN TEACH.

- 5 Use **OK** key to confirm your selection:

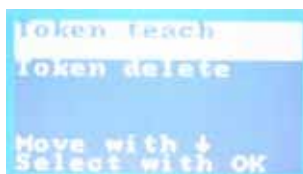

- 6 Press **B** key "down-arrow" to select submenu TOKEN DELETE.

- 7 Use **OK** key to confirm your selection.

- 8 If necessary, use **B** key "down-arrow"/**A** key "up-arrow" to select token (TOKEN A, TOKEN B or TOKEN C) that is no longer to be accepted.

- 9 Use **OK** key to confirm your selection.

Token configuration has been erased. The coin channel is free to be programmed with another token.

- 10 Use **MENU** key to return to the main menu

6 Firmware update

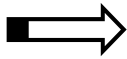

In this chapter you learn how to update the c² firmware by means of the HENRI service tool, also using a HENRI SIM card, if available.

The currenza c² is fitted with three or four microcontrollers the firmware (FW) of which can be updated:

- coin changer/interface module FW
- coin validator FW
- display FW
- audit module FW

Before updating the relevant FW you can display the current FW versions. In order to finally update the FW it must either

- be loaded from the PC into the HENRI and then installed in the currenza c² using HENRI, or
- be installed in the currenza c² using a HENRI SIM card with the latest coin changer FW also by means of the HENRI service tool.

Displaying current firmware versions

In order to display the current FW versions of the currenza c².

- 1** Connect c² green/white/orange with HENRI service tool (plug HENRI RJ-45 connector into coin changer socket in the upper right hand corner, cp. separate HENRI short reference guide).
HENRI switches to c² mode automatically and shows the (vending machine) display in normal operating mode, e.g., the current change stock, if there is no error.

- 2** Press **HENRI** key.
You enter the main menu:

```

HENRI menu
A- FW update
B- Exten. funct.
C- Settings
D- Changer modes
E- DB update
MENU- CC menu
  
```

- 3** Press **A** key to open the **UPDATE** menu:

```

Update menu
A- CoinValidator
B- Coin Changer
C- Display
D- Audit
E- FW versions
EXIT- Exit
  
```

- 4** Press **E** key to display **FW VERSIONS**.
- 5** Use **EXIT** key to return to the main menu.

Updating firmware using PC & HENRI

First of all the new firmware must be stored in the HENRI service tool by means of the PC software HenriFlash, so that you can use the service tool to install the firmware in the coin changer.

Downloading new firmware and FW update PC application from the internet

HenriFlash can be downloaded from the NRI website (www.nri24.com, Internal) either as zipped file along with the latest FW or as .exe file using your customer password.



Should you have any further questions, please do not hesitate contacting our sales staff at any time.

Installing HenriFlash

To install the program on the hard disc of your PC:

1 If necessary, unpk zipped file.

In addition to HenriFlash this directory also contains the firmware:

- xxx.cxb (coin validator FW)
- xxx.mot (coin changer FW)
- xxx.dsp (display FW)
- xxx.aud (audit modul FW)



The directory may also contain a file with the extension .hen. This file is the current FW for the HENRI service tool (cp. separate HENRI short reference guide).

2 Start .exe file and follow the installation wizard.
HenriFlash is installed.

Loading new c² firmware in HENRI

- 1 Connect the USB cable provided to the PC.
- 2 Start HenriFlash.

The start screen together with a selection box opens:

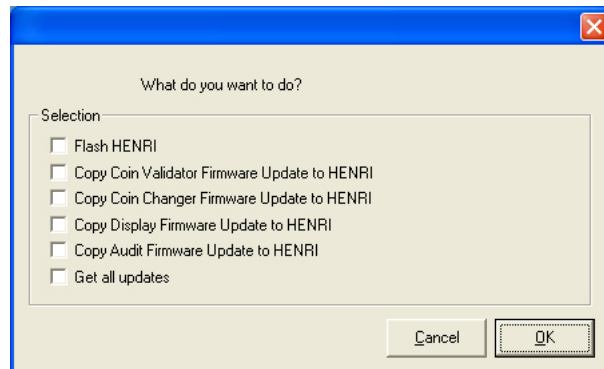

- 3 Select FW to be updated:
 - for c² coin validator **COPY COIN VALIDATOR FIRMWARE ...**
 - for c² coin changer **COPY COIN CHANGER FIRMWARE ...**
 - for c² display **COPY DISPLAY FIRMWARE ...**
 - for c² audit module **COPY AUDIT FIRMWARE ...**
 - for all four c² components **GET ALL UPDATES**
- 4 Confirm your selection with **OK**.



Now you can set the menu language required by selecting the **LANGUAGE** menu.



- 5** In the left field FILE SELECTION and in the line of the appropriate FIRMWARE, enter the path of the directory started during installation and firmware file.
- 6** Connect HENRI to the USB cable's free end and wait until the service tool had booted up and displays the menu.
- 7** Click **UPDATE** to start data transfer from the PC to the service tool. HenriFlash displays the data transfer status in the right-hand OUTPUT field.

Installing new firmware in the coin changer

- 1** Connect c² green/white/orange with HENRI service tool (plug HENRI RJ-45 connector into coin changer socket in the upper right hand corner, cp. separate HENRI short reference guide).
HENRI switches to c² mode automatically and shows the (vending machine) display in normal operating mode, e.g., the current change stock, if there is no error.
- 2** Press **HENRI** key.
You enter the main menu:

```

HENRI menu
A- FW update
B- Exten. funct.
C- Settings
D- Changer modes
E- DB update
MENU- CC menu

```

- 3** Press **A** key to open the UPDATE menu:

```

Update menu
A- CoinValidator
B- Coin Changer
C- Display
D- Audit
E- FW versions
EXIT- Exit

```

- 4**
 - Press **A** key to update COIN VALIDATOR FW.
 - Press **B** key to update COIN CHANGER FW.
 - Press **C** key to update DISPLAY FW.
 - Press **D** key to update AUDIT module FW
HENRI displays the appropriate:
 - CURRENT VERSION (FW installed in the currenza c² yet)
 - NEW VERSION (FW in HENRI to be installed)
- 5** Press **OK** key to update the relevant firmware in the currenza c².
- 6** Use **EXIT** key to return to the main menu.



If an error should occur during data transfer, the baud rate can be adapted in the service tool, if necessary (see separate HENRI short reference guide).

Updating firmware using SIM card & HENRI

The HENRI service tool also enables you to update the currenza c² firmware just by inserting a HENRI SIM card, if necessary along with new coin and device configurations (currency & configuration data block).

For this you will need a HENRI SIM card providing the required coin changer firmware. The customised SIM card can be ordered by contacting our sales staff.



As the data transfer will start automatically when inserting the SIM card and will not end until all data has been transferred, the SIM card may only provide the data (firmware or data blocks) supposed to be programmed when inserting the card.

If for any reason the card memorises several firmware files for different coin changer modules or firmware and data block files for a new configuration, this data will be transferred at once and cannot be separated, i.e. firmware and configuration would be updated at once.

To update the firmware:

- 1 Insert the HENRI SIM card with the latest firmware into the HENRI "SIM" interface.



Please consider the arrow and side indication on the SIM card.

Depending on the model year of the HENRI service tool the "SIM" interface is either right next to the "USB" interface or on the left-hand side (Fig. 2).

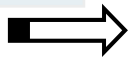

Fig. 2: Inserting SIM card

- 2 Connect c² with HENRI service tool (plug HENRI RJ-45 connector into coin changer socket in the upper right hand corner, cp. separate HENRI short reference guide).
HENRI found the SIM card and asks whether to start the firmware update.
- 3 Confirm query and press the **OK**-key.
HENRI displays the status of the firmware installation and confirms with **UPDATE COMPLETED**.
- 4 Use **EXIT** key to return to the main menu.

7 Audit (option)

If the currenza c² is fitted with an optional internal audit module, all audit data is collected and evaluated by the changer, so that it may be read out using a mobile data retrieval unit (MDE) or rather printed using a mobile printer for audit purposes.



This chapter describes how to

- check audit data with HENRI.
- read out audit data using the IrDA interface.
- print audit data using a mobile printer.

Checking audit data with HENRI

First of all this section lists which audit data is recorded and how it is structured, which means: which audit data can be found in which submenu.

The next section explains how to display particular audit data using the HENRI service tool.

Which audit data is recorded and in what structure?

The audit data can be divided into three groups: General data, Vending data and data regarding the flow of money. Accordingly the AUDIT menu is divided into three submenus:

- GENERAL DATA
- VENDS
- FLOW OF MONEY

General data

The submenu GENERAL DATA contains all general audit data of the coin changer currenza c²:

- MACHINE NUMBER (10-digit)
- NUMBER OF PRINTOUTS/READOUTS:
 - since installation
 - since initialisation
 - Date and time of last readout
- NUMBER OF POWER RESETS
 - since initialisation
 - since last readout
- TUBE CONTENTS
 - Amount of coins collected in tube A to F
 - Total amount of all coins collected
- RECYCLER CONTENT (if connected)

Vends

In the VENDS submenu you may catch up on sales transacted using the coin changer currenza c²:

- SALES OF ALL PAYMENT SOURCES
 - since initialisation
 - since last readout
 - cycles (since initialisation, since last readout)
- CASH SALES
 - since initialisation
 - since last readout
 - cycles (since initialisation, since last readout)
- CASHLESS SALES
 - since initialisation
 - since last readout
 - cycles (since initialisation, since last readout)
- TOKEN SALES
 - since initialisation
 - since last readout
 - cycles (since initialisation, since last readout)
- FREE VENDS
 - since initialisation
 - since last readout
 - cycles (since initialisation, since last readout)

- FREE VENDS WITH TOKENS
 - since initialisation
 - since last readout
 - cycles (since initialisation, since last readout)
- TEST VENDS
 - since initialisation
 - since last readout
 - cycles (since initialisation, since last readout)
- DISCOUNTS
 - since initialisation
 - since last readout
 - cycles (since initialisation, since last readout)
- SALES PER SELECTION LINE (selection line/product 001 to 100)
 - since initialisation
 - since last readout
 - cycles (since initialisation, since last readout)

Flow of money

In the submenu FLOW OF MONEY you may catch up on acceptance and payout of the individual means of payment:

- Coins
- Banknotes
- Card systems
- Tokens

Coin acceptance/payout

The audit data for acceptance and payout of coins is listed in the COIN DATA submenu:

- COINS TO CASH-BOX
 - since initialisation
 - since last readout
- COINS TO TUBE
 - since initialisation
 - since last readout
- CHANGE PAID OUT
 - since initialisation
 - since last readout
- CHANGE PAID OUT FROM HOPPERS
 - since initialisation
 - since last readout

- COINS TO TUBE IN MANUAL FILLING MODE
 - since initialisation
 - since last readout
- COINS PAID OUT MANUALLY
 - since initialisation
 - since last readout
- CASH OVERPAY
 - since initialisation
 - since last readout
- CREDITED FROM MACHINE
 - since initialisation
 - since last readout
- COIN COUNTERS
 - for accepted coins (01 to 16) since initialisation/since last readout
 - for coins into tubes (A to F) since initialisation/since last readout
 - for coins out of tubes (A to F) since initialisation/since last readout

Banknote acceptance/payout

The audit data for acceptance and payout of banknotes is listed in the BILL DATA submenu:

- ACCEPTED BILLS
 - since initialisation
 - since last readout
- BILLS TO RECYCLER
 - since initialisation
 - since last readout
- BILLS PAID OUT
 - since initialisation
 - since last readout
- BILLS IN MANUALLY
 - since initialisation
 - since last readout
- BILLS OUT MANUALLY
 - since initialisation
 - since last readout

Flow of money using card system

The audit data for in and out of cards is listed in the CASHLESS DATA submenu:

- DEBITED FROM CASHLESS
 - since initialisation
 - since last readout
 - cycles (since initialisation, since last readout)
- CREDITED TO CASHLESS
 - since initialisation
 - since last readout
 - cycles (since initialisation, since last readout)
- DISCOUNTS FROM CASHLESS
 - since initialisation
 - since last readout
 - cycles (since initialisation, since last readout)
- TOKENS FROM CASHLESS
 - since initialisation
 - since last readout
 - cycles (since initialisation, since last readout)

Tokens

The audit data for tokens is listed in the TOKEN submenu:

- ACCEPTED TOKENS
 - since initialisation
 - since last readout
- TOKEN OVERPAY
 - since initialisation
 - since last readout
- FREEVEND TOKENS
 - since initialisation
 - since last readout

Displaying audit data



The following abbreviations are used to display the audit data:

"Inst." = since installation

"s.Ini." = since initialisation

"s.I.R." = since last readout.

- 1 Connect c² green/white/orange with HENRI service tool (plug HENRI RJ-45 connector into coin changer socket in the upper right hand corner, cp. separate HENRI short reference guide).
HENRI switches to c² mode automatically and shows the (vending machine) display in normal operating mode, e.g., the current change stock, if there is no error.
- 2 Press **HENRI** key.
You enter the main menu:

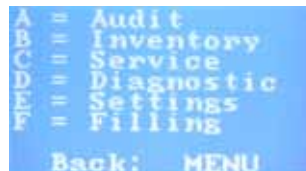

- 3 Press **A** key to open the **AUDIT** menu:

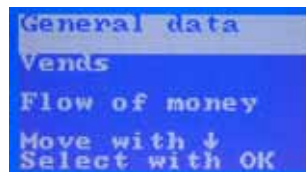

- 4 Use **B** key or **A** key (down-arrow/up-arrow) to select type of audit data: General data, vending data, data about flow of money (see previous section).
- 5 Use **OK** key to confirm your selection.
- 6 Use **B** key or **A** key (down-arrow/up-arrow) to select required audit data (see previous section).
- 7 Use **OK** key to confirm your selection.
- 8 Use **EXIT** key to go to the superordinated menu to display further audit data or use **MENU** key to return to the main menu.

Reading out audit data using the IrDA interface

If your coin changer has no integrated IrDA interface, you will require an NRI infrared adapter as an optical interface (cp. also product accessory pages at www.nri24.com) in order to be able to read out the audit data via an infrared data retrieval unit (MDE). The following signals can be received:

- timed IR signals (for older MDEs) or
- IrDA signals



The language of the audit data has been selected with the dialogue language (cp. Chap. 2 “Menu language”).

To read out the audit data:

- 1** If necessary, plug the infrared adapter in the 9-pole D-Sub printer cable of the changer.
- 2** Hold the infrared interface of the MDE in the direction of the coin changer/adapter.
- 3** Start data transmission on the MDE.



If data is read out with an MDE, the changer automatically inhibits the deletion of audit data following a printout, and the vending machine number cannot be altered.

Printing out audit data using a mobile printer

The changer is equipped with an interface (9-pole D-Sub plug) for connecting a printer (e.g. NRI printer G-55.0510, cp. also product accessory pages at www.nri24.com).

Depending on the printer connected, the printout is either activated immediately or after a start button has been pressed.



If the printer does not have a start button and the printout is activated only by connecting the device, the printer line must be monitored by the changer to ensure that the printer does not print out data over and over again (cp. separate configuration manual).

The language of the audit data has been selected with the dialogue language (cp. Chap. 2 "Menu language").

Following a printout, the audit data is not deleted until the next time a coin is inserted. Until then you can repeat the printout as often as you wish.

When printing out the audit data, please note the following possible settings (cp. separate configuration manual):

- Machine number
- Printer type (with or without start button)
- Printer language
- Extra broad printout (24 characters/line), so that audit data is separated in "since initialisation" and "since last printout" and can be printed out side by side
- Which audit data is to be printed?
- Is the time to be printed?

8 Readout of statistical data

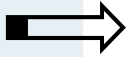

In this chapter you learn how to use the HENRI service tool to

- read out statistical data from the currenza c² and
- erase statistical data from the HENRI memory.

The currenza c² memorises statistical data of turnovers, cash flow and errors, which can be read out by an NRI service technician. In case the HENRI memory is full and all relevant data has been transmitted to a PC the statistics can be erased.

Reading out statistical data from the currenza c²

To read out the statistical data:

- 1 Connect c² green/white/orange with HENRI service tool (plug HENRI RJ-45 connector into coin changer socket in the upper right hand corner, cp. separate HENRI short reference guide).

HENRI switches to c² mode automatically and shows the (vending machine) display in normal operating mode, e.g., the current change stock, if there is no error.

- 2 Press **HENRI** key.

You enter the main menu:

```

HENRI menu
A- FW update
B- Exten. funct.
C- Settings
D- Changer modes
E- DB update
MENU- CC menu
    
```

- 3 Press **B** key to open the menu EXTENDED FUNCTIONS:

```

Exten. Funct.
A- c2 stat. data
B- Function test
C- Clone
D- Channels
E- Decimal point
EXIT- Exit
    
```

- 4 Press **A** key to open the submenu c² STATISTICAL DATA:

```

c2 Stat. data
A+ Store
B+ Delete
EXIT+ Exit
    
```

- 5 Press **A** key again to save the statistical data.

The bottom line displays the free space left on the HENRI memory (e.g. "001/128"):

```

Statistical data
has been
stored

001/128
-----
EXIT+ Exit
  
```



If HENRI displays "128/128", the memory is full and the stored statistics must be erased (see next section).

Erasing statistical data from HENRI memory

To erase all c² statistics stored in HENRI:

- 1 Connect c² green/white/orange with HENRI service tool (plug HENRI RJ-45 connector into coin changer socket in the upper right hand corner, cp. separate HENRI short reference guide). HENRI switches to c² mode automatically and shows the (vending machine) display in normal operating mode, e.g., the current change stock, if there is no error.

- 2 Press **HENRI** key.

You enter the main menu:

```

HENRI menu
-----
A- FW update
B- Exten. funct.
C- Settings
D- Changer modes
E- DB update
MENU- CC menu
  
```

- 3 Press **B** key to open the menu EXTENDED FUNCTIONS:

```

Exten. Funct.
-----
A- c² stat. data
B- Function test
C- Clone
D- Channels
E- Decimal point
EXIT- Exit
  
```

- 4 Press **A** key to open the submenu c² STATISTICAL DATA:

```

c² Stat. data
-----
A+ Store
B+ Delete

EXIT+ Exit
  
```

- 5** First press the **B** key and then the **E** key if you really want to delete all c² statistics, if not, use the **F** key to cancel the procedure:



9 Cleaning

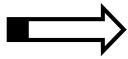

This chapter describes how to clean the coin changer:

- Coin path
- Sorting module
- Payout sensor system
- Filling level sensor system



To avoid damage of any kind during maintenance work, please consider the safety instructions specified below:

- Turn the power off before cleaning the coin changer.
- Under no circumstances may the coin changer be immersed or the cleaning cloth be so wet that fluid runs into the device. Other the PCBs and optics will be damaged.
- Do not use any solvents or scouring agents which attack the plastic of the device.

Cleaning coin path in validation and sorting area (yearly)

The coins may leave residues on sensitive parts, when passing through the coin validator. These residues must be removed from time to time, in order to guarantee a reliable coin acceptance and rejection.

- Cleaning interval: yearly, as required
- Cleaning aids: compressed air/small brush/slightly wet cloth luke warm water

To clean the coin path in the validation and sorting area:

- 1** Turn power off.
- 2** Unlatch sorter cover (blue latch on the right side) [3/A].
- 3** Swing sorter cover open [3/B].
- 4** Open flight deck at the insert funnel and hold it open [3/C].

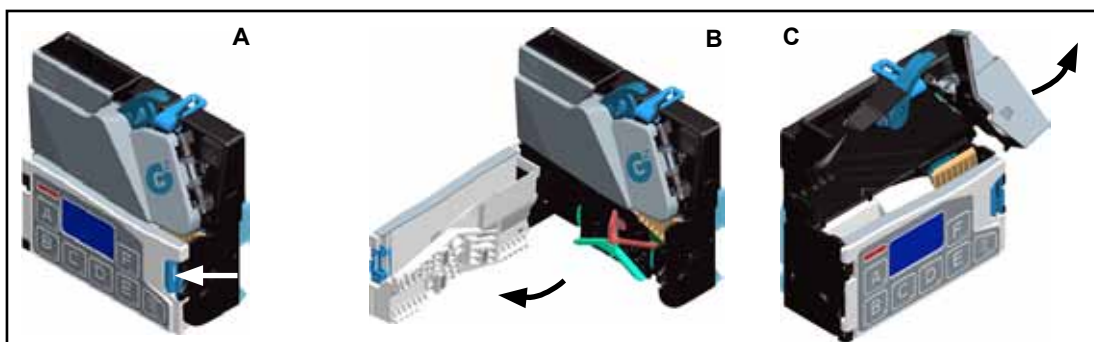

Fig. 3: Opening coin validator's sorter cover and flight deck

- 5** Remove any debris from the validation and sorting area. Dust off any accumulation with a small brush or compressed air.
- 6** Clean complete coin path, front and back, with a slightly wet cloth.
- 7** Allow to dry.
- 8** Close flight deck and latch sorter cover.
- 9** Turn power ON.





Cleaning payout sensor system

If more and more errors occur, when the coin changer pays out coins or if coins can no longer be paid out without difficulty, the payout sensor system is likely soiled and must be cleaned in order to guarantee a reliable change payout again.

First of all check the position sensor values of the payout motors and display the appropriate diagnostic screen. The values for the sensors L1/2, M1/2 and R1/2 must all be higher than 100:

Quick approach:

 = Main menu > **D** = Diagnostics > Motor sensors

	Press key ...	How often?	Effect
1		1 x	You enter the main menu
2		1 x	You enter the DIAGNOSTICS menu
3		until Motor sensors	You want to enter this diagnostic screen
4		1 x	The c ² displays the sensor values for test purposes
5		1 x/2 x	You return to main menu/operating mode

If one or several values are lower than 100, the payout sensor system must be cleaned:

- Cleaning interval: With motor sensor errors
- Cleaning aids: Dry cloth, brush (with fine fibres, never metal)/ soft toothbrush



By all means, clean dryly. Moisture can damage the sensor system.

- 1** Turn power OFF.
- 2** Remove coin changer from the machine.
- 3** Remove coin cassette [4/A, B].

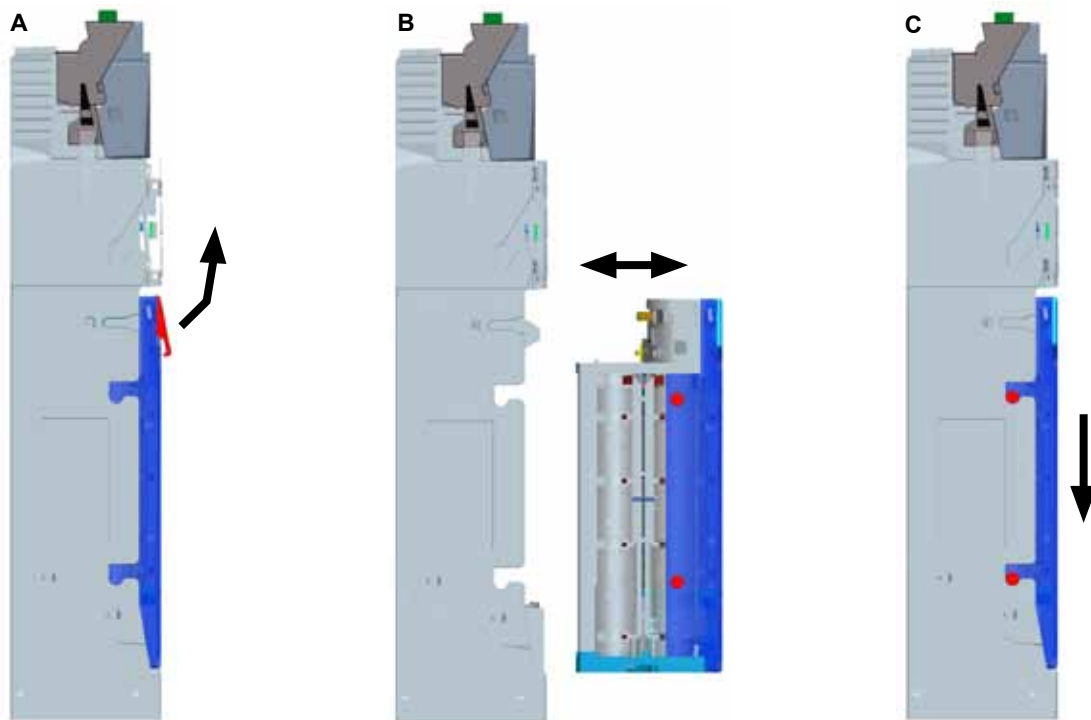

Fig. 4: Removing and reinstalling the coin cassette



Please take note of the correct position and alignment of the payout discs in order that you can reinstall them correctly after cleaning.

- 4** Grab under the middle payout disc and strongly press the disc out from the payout set from the bottom (Fig. 5).
- 5** Press out the left and right payout discs as well.
- 6** Clean payout discs with a dry cloth and sensors in the payout disc receptacles with a brush or a dry toothbrush (red markings in Figs. 6 and 7).
- 7** Reinstall payout discs correctly aligned in the original position and fix them by firmly pressing the lockings down until they engage (Fig. 5).

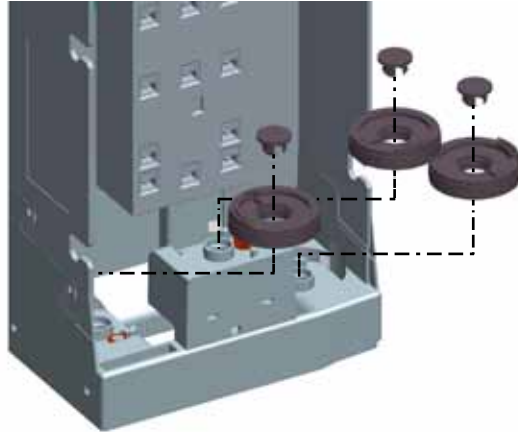

Fig. 5: Removing and reinstalling payout discs and lockings



Fig. 6: Sensors on payout disc

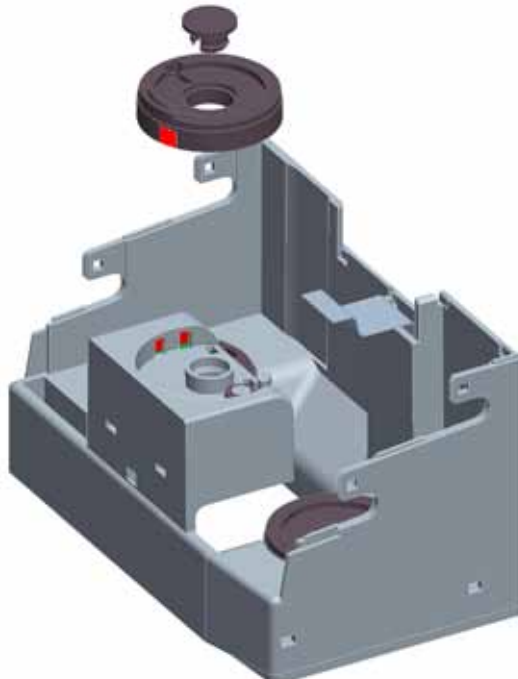

Fig. 7: Sensors on payout disc receptacle

- 8** Reinsert coin cassette straight in and down until it clicks in position [4/B, C].
- 9** Reinstall coin changer in the machine.
- 10** Turn power on again.
- 11** Check sensor values of the payout motors again (see above).
All values must be higher than 100 now.



If the cleaning procedure has not improved the sensor values, the payout sensor system is defective.









Cleaning filling level sensor system

If the currenza c² reports unrealistic tube filling levels, e.g. c² signals tube is full and the tube coins are misrouted to the cash-box though the tube is empty or at least not completely filled, please first of all check the values of the filling level sensors and display the diagnostics menu. For this empty the coin cassette and make use of the HENRI service tool, if necessary.

Diagnostics

Quick approach:

 = Main menu >  = Diagnostics >  Sensor left (tubes A&B)/ middle (tubes C&D)/ right (tubes E&F)

Press key ...	How often?	Effect
1 	1 x	You enter the main menu
2 	1 x	You enter the DIAGNOSTICS menu
3 	until <i>Sensor left</i> (e.g.)	You want to enter the diagnostic screen for tubes A & B
4 	1 x	You enter the diagnostic screen and may check the readings (see below)
5 	1 x	You want to go back to the diagnostics menu
6 	1 x	You want to enter the diagnostic screen for tubes C & D
7 	1 x	You enter the diagnostic screen and may check the readings (see below)
8	<i>Repeat steps 5–7 to check the right sensors for tubes E&F</i>	
9 	1 x/2 x	You return to main menu/operating mode

	A	B
R	186	186
S4	175	171
S3	177	173
S2	175	173
S1	171	123
Back:	EXIT	

Fig. 8: Fine tube A&B readings with empty cassette

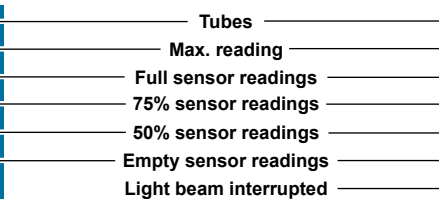

	A	B
R	181	181
S4	003 1	003 1
S3	001 1	000 1
S2	001 1	001 1
S1	001 1	000 1
Back:	EXIT	

Fig. 9: Tube A&B readings with light beam interrupted (e.g. cassette removed)

Readings when optics are OK

The following readings should be displayed when the filling level sensors are checked with an empty coin cassette:

R > 150

S1–S4 > 50

Readings when optics need to be monitored continuously

The following readings for an empty coin cassette are tolerable limits but must be monitored continuously:

R < 150

S1–S4 < 50

Readings when optics are faulty

The following readings, also for an empty coin cassette, call for action:

R < 100

S1–S4 < 30

Causes: – cassette not engaged correctly/assembled properly
– imperfections with the filling level optics

S1–S4 = almost 0 and “1”

Causes: light beam interrupted, e.g., cassette removed, emitter/receiver damaged/missing

Locating the failure cause (Golden Unit test)

In order to ascertain which hardware part is soiled or defective please make use of a golden c² unit working absolutely reliably and conduct a so-called Golden Unit Test:

- 1 Replace the supposedly soiled/defective coin cassette with the golden coin cassette.
- 2 Check the values of the filling level sensors again (cp. ⁱⁱⁱ, p. 69).
If the readings are OK now, the replaced coin cassette is most likely soiled or defective (cp. "Cleaning in the field", p. 57).
If they are still low, the interface module is cause of the malfunction and must be cleaned or replaced (cp. "Cleaning interface module", p. 58).



You may confirm the test result by replacing the golden coin cassette with the supposedly defective coin cassette.

Cleaning in the field

Please clean either the coin cassette or the interface module depending on the Golden Unit Test result.

Cleaning coin cassette

If the light transmitter and light collectors are dusty, you should clean most of all the reflecting surfaces.

- Cleaning interval: with filling level sensor errors/if dusty
- Cleaning aids: Isopropanol (available at the pharmacist)
cotton bud, microfiber cloth



Do not use water, any solvents, scouring agents and paper towels or kitchen paper which attack the sensitive surfaces of the optical parts or leave residues.

- 1 Remove the coin cassette from the coin changer [Fig. 4].
- 2 Use a cotton bud with Isopropanol to clean all accessible reflecting surfaces and most of all the 45° surfaces [Fig. 10].
- 3 Thoroughly dry all surfaces as residue-free as possible using a microfiber cloth [Fig. 10]:
 - The light transmitter from behind
 - The two lateral light collectors from the side
- 4 Reinsert coin cassette.

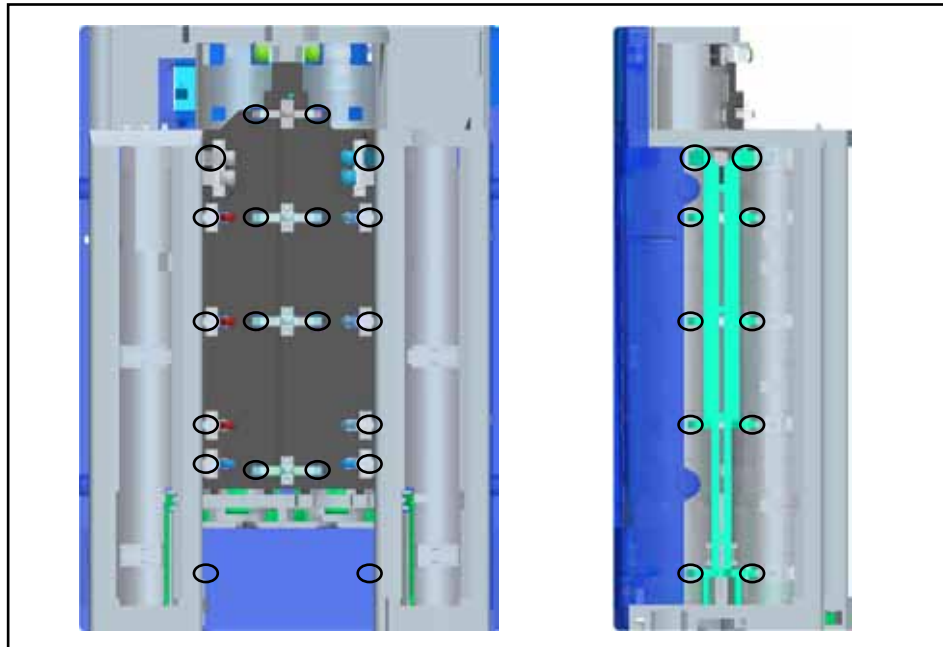

Fig. 10: Rear and side view of coin cassette –
all 45° surfaces accessible

- 5** Check the values of the filling level sensors again (cp. “”, p. 69).
If the sensor values are still low after the cleaning procedure:
- 6** • please contact your service technician or
 - clean disassembled coin cassette (cp. “Cleaning in the workshop”, p. 60, only for service technicians with certified NRI training).

Cleaning interface module

If the interface module’s emitters and receivers are dusty, they must be cleaned.

- Cleaning interval: with filling level sensor errors/if dusty
- Cleaning aids: brush (with fine fibres, never metal)



Do not use water, any solvents, scouring agents and paper towels or kitchen paper which attack the sensitive surfaces of the optical parts or leave residues.

- 1** Remove coin cassette from coin changer [Fig. 4].
- 2** Use a brush to carefully free all emitters and senders from dust through the cut-outs in the housing [Fig. 11].
- 3** Reinstall coin cassette [Fig. 4].
- 4** Check the values of the filling level sensors again (cp. “”, p. 69).

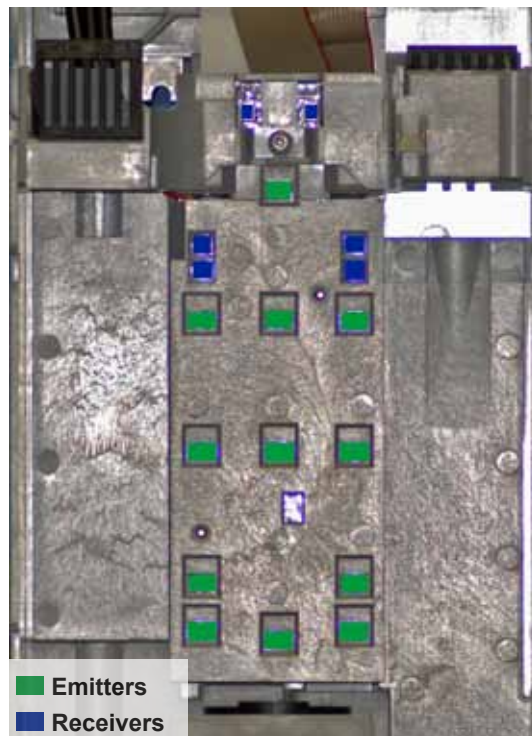

Fig. 11: Housing cut-outs for emitters & receivers on interface module

If the sensor values are still low after the cleaning procedure, a component is most likely defective and the interface module must be replaced (cp. c² spare parts list).

Cleaning in the workshop

To make all of the optical parts of the coin cassette accessible (light collectors and light transmitters), you have to disassemble the coin cassette. The final cassette assembly requires an NRI training.



Reassembling the coin cassette parts only for service technicians with certified NRI training!

NRI does not give any warranty for the use of coin cassettes mounted by unauthorised persons and is not liable for any emanating damage or faulty functioning!

- Cleaning interval: with filling level sensor errors/if soiled
- Cleaning aids: Isopropanol (available at the pharmacist)
cotton bud, microfiber cloth
- Tools: screw driver PZ1

Disassembling coin cassette



When disassembling the coin cassette, keep in mind where and how the parts have been mounted. If the light collectors, tubes with special adapter rings and size acceptance limiters will be mounted in the wrong position or direction, the sensor and payout system or coin sorting does no longer work.

- 1** Remove the coin cassette and put it on a flat surface such as a table with the label pointing backwards.
- 2** Unscrew and remove the 2 rear screws [Fig. 12/1] on the top and keep them safe for reassembly.
- 3** Detach the top tube support for the middle tubes [Fig. 12/2].
- 4** Carefully extract the two middle tubes [Fig. 12/3] from the cassette.
- 5** Carefully extract the middle light collector [Fig. 12/4] from the cassette.
- 6** Unscrew and remove the 4 other screws [Fig. 12/5] on the top and keep them safe for reassembly as well.
- 7** Now also detach the top tube supports for the left-hand and right-hand tubes [Fig. 12/6] and memorise the way they were mounted. Perhaps the lateral light collectors [Fig. 12/7] got stuck in the tube supports. If so, keep also their position in mind and
- 8** pull the two light collectors out of the top tube supports. If not
- 9** pull the two light collectors out of the bottom tube supports [Fig. 12/8].
- 10** Carefully remove the two front tubes [Fig. 12/9].
- 11** Then slightly move the lower part of the light transmitter [Fig. 12/10] to the front and remove it.

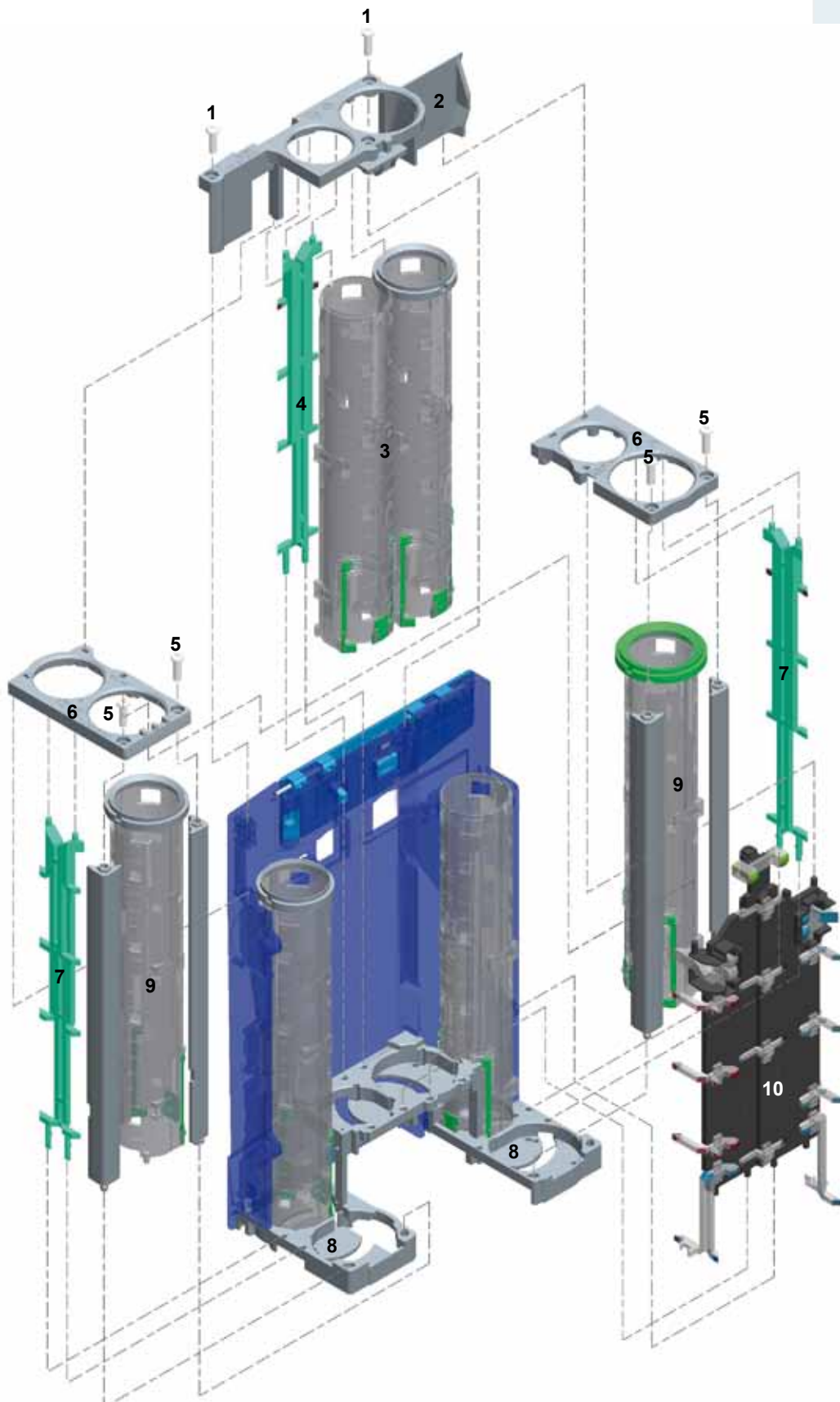

Fig. 12: Assembly plan for coin cassette

Cleaning coin cassette

The residues of coins and dust left on sensitive parts of the light transmitter and light collectors must be removed in order to guarantee a reliable coin changer operation:



Do not use water, any solvents, scouring agents and paper towels or kitchen paper which attack the sensitive surfaces of the optical parts or leave residues.

- 1** Clean all reflective surfaces and most of all the 45° surfaces of the light transmitter and the 3 light collectors with a cotton bud dipped into Isopropanol [Fig. 13].
- 2** Thoroughly dry all surfaces cleaned as residue-free as possible using a microfiber cloth.

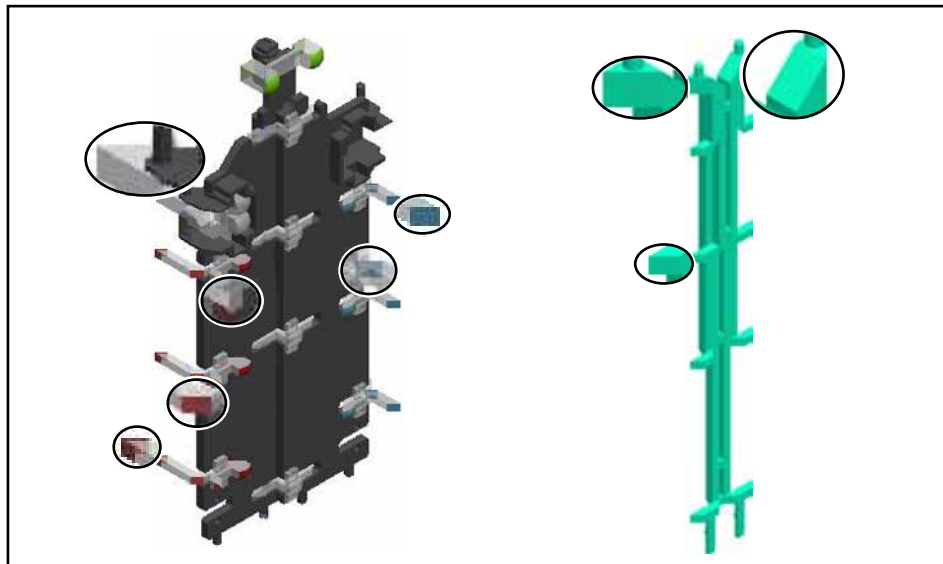

Fig. 13: 45° surfaces of light transmitter and light collectors

Reassembling coin cassette



To make it easier to reinstall the three light collectors, they are numbered from 1 to 3 at the bottom pins [Fig. 14]:

- Light collector 1: For tubes E & F (left side when reassembling)
- Light collector 2: For tubes C & D (middle)
- Light collector 3: For tubes A & B (right side when reassembling)

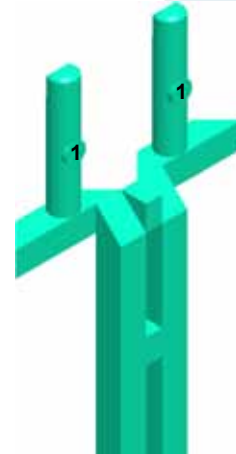

Fig. 14: Light collector numbering

- 1** Reinsert the light transmitter [Fig. 12/10], so that the four underside pins fit in the four appropriate holes of the cassette frame.
- 2** Reinsert the middle light collector [Fig. 12/4] with the 45° reflecting surfaces facing to the blue main part of the cassette.
- 3** Reinsert the two middle tubes [Fig. 12/3] and front tubes [Fig. 12/9] also with the two pins fitting in the bore holes of the cassette frame.
- 4** Reinsert the two lateral light collectors [Fig. 12/7] in the bottom tube supports with the 45° reflecting surfaces facing outwards.
- 5** Make sure that all tubes still fit in the bore holes of the cassette frame.
- 6** Reattach the top tube supports for the left-hand and right-hand tubes [Fig. 12/6], so that they fix the tubes, light collector and light transmitter and fasten them with the screws. Perhaps it is necessary to slightly realign the light collector and transmitter in order that the parts interlock.
- 7** Reattach the top tube support for the middle tubes [Fig. 12/2], so that it fixes the tubes, light transmitter and lateral tube supports and also fasten it with the two left screws [Fig. 12/1].
- 8** Check the values of the filling level sensors again (cp. "", p. 69). If the sensor values are still low after the cleaning procedure, the coin changer has to be returned to NRI for repair purposes.

10 Troubleshooting



Malfunctions can occur in all electronic devices. Dabei muss es sich nicht immer um einen Fehler am Gerät handeln. In many cases improper connections or incorrect settings are the reason.

This chapter



- lists cause and correction of c² malfunctions.
- explains quick diagnosis using status LEDs of the c² green.
- describes, how to display detailed information about certain coin changer units by means of the diagnostic menu.



c² status & error messages

If there is a fault, the c² blue coin changers display the appropriate status or error message. c² coin changers with other user interfaces display the messages as soon as the HENRI service tool is connected. Some messages are only for information about particular operating states.

Please check first of all whether the malfunction can simply be remedied using the following table.

Problem/error message	Possible causes	Remedy, hints
NO COMMUNICATION WITH VMC	MDB/JVI coin changer has not received any machine commands for 10 seconds	<ul style="list-style-type: none"> • Connect cable to the vending machine correctly • Power vending machine
NO RESPOND FROM VMC	BDV/Executive vending machine does not respond to coin changer commands	<ul style="list-style-type: none"> • Connect cable to the vending machine correctly • Power vending machine
NO RESPOND FROM EXTERNAL AUDIT UNIT	External audit unit does not respond to coin changer commands as <ul style="list-style-type: none"> • not connected correctly • not available 	<ul style="list-style-type: none"> • Check proper connection • Deactivate communication with audit unit (cp. separate c² configuration manual, Chap. "Peripheral")
COIN JAM IN FLIGHT DECK	Sensor error in coin validator: <ul style="list-style-type: none"> • Sensor covered • Sensor defective 	<ul style="list-style-type: none"> • Remove coin jam • Clean coin path (cp. "Cleaning", p. 51) • Display coin validator diagnostic screen (cp. "", p. 69), if necessary, contact service technician
COIN JAM IN THE SORTING MODULE	Sensor error in coin validator: <ul style="list-style-type: none"> • Sensor covered • Sensor defective 	<ul style="list-style-type: none"> • Remove coin jam • Clean sorter (cp. "Cleaning", p. 51) • Display coin validator diagnostic screen (cp. "", p. 69), if necessary, contact service technician

Problem/error message	Possible causes	Remedy, hints
ERROR IN SIZING OPTICS	Sensor error in coin validator: <ul style="list-style-type: none"> • Sensor covered • Sensor defective 	<ul style="list-style-type: none"> • Remove coin jam • Clean coin path (cp. "Cleaning", p. 51) • Display coin validator diagnostic screen (cp. " ", p. 69), if necessary, contact service technician
CHECKSUM OF VALIDATOR DEFECTIVE	Error in coin validator's data memory	Check and correct coin validator configuration by means of heartbeat
NO RESPONSE FROM VALIDATOR MODULE	<ul style="list-style-type: none"> • Communication with coin validator interrupted • Coin validator defective 	<ul style="list-style-type: none"> • Remove rear cover from coin changer, unfold coin validator and check whether ribbon cable is still connected correctly with interface module (bottom PCB) and coin validator • Replace coin validator
TUBE SENSORS DEFECTIVE	<ul style="list-style-type: none"> • Filling level sensors soiled • Filling level sensors defective 	<p>Display diagnostic screen for filling level sensors (cp. " ", p. 69)</p> <ul style="list-style-type: none"> • Clean filling level sensor system (cp. "Cleaning", p. 51) • If necessary, replace interface module • If necessary, contact service technician and replace the coin cassette's filling level sensor system
CHECKSUM OF CHANGER DEFECTIVE	Error in coin changer's data memory	Check and correct coin changer configuration in the SETTINGS menu, if necessary by means of the HENRI service tool
NO RESPONSE FROM CASHLESS SYSTEM	Card system does not respond to coin changer commands as <ul style="list-style-type: none"> • not connected correctly or defective • no longer available 	<ul style="list-style-type: none"> • Check card system • Deactivate communication with card system (cp. separate c² configuration manual, Chap. "Peripheral") <p> <i>Warning is being displayed for 60s, afterwards the c² deactivates the card system.</i></p>
NO RESPONSE FROM BILL VALIDATOR	Bill validator does not respond to coin changer commands as <ul style="list-style-type: none"> • not connected correctly or defective • no longer available 	<ul style="list-style-type: none"> • Check bill validator • Deactivate communication with bill validator (cp. separate c² configuration manual, Chap. "Peripheral") <p> <i>Warning is being displayed for 60s, afterwards the c² deactivates the bill validator.</i></p>
NO COMMUNICATION WITH HOPPER	Hopper does not respond to coin changer commands as <ul style="list-style-type: none"> • not connected correctly or defective • no longer available 	<ul style="list-style-type: none"> • Check hopper • Deactivate communication with hopper (cp. separate c² configuration manual, Chap. "Peripheral") <p> <i>Warning is being displayed for 60s, afterwards the c² deactivates the hopper.</i></p>

Problem/error message	Possible causes	Remedy, hints
NO COMMUNICATION WITH RECYCLER	<p>Recycler does not respond to coin changer commands as</p> <ul style="list-style-type: none"> not connected correctly or defective no longer available 	<ul style="list-style-type: none"> Check recycler Deactivate communication with recycler (cp. separate c² configuration manual, Chap. "Peripheral") <p> <i>Warning is being displayed for 60s, afterwards the c² deactivates the recycler.</i></p>
PAYOUT JAM IN TUBE: X, X, X	<p>Payout disc could not be driven from or in initial position as</p> <ul style="list-style-type: none"> Coin got stuck in payout area Payout disc got jammed Payout motor defective 	<ul style="list-style-type: none"> Remove coin cassette and then jammed coin. Reinsert cassette and pay out coin from relevant tube using inventory key. The error will be reset Remove coin cassette, dismount and reinsert disc. For this cp. "Cleaning payout sensor system", p. 52. If the coin cassette has been removed, the c² tries after 10s to turn the disc in final position again and resets the error Contact service technician or replace payout set
CHECK POSITION OF TUBE CASSETTE	<ul style="list-style-type: none"> Coin cassette not inserted and engaged correctly New coin cassette not suited for old housing <p> <i>New coin cassettes (delivered since Nov. 2008) are fitted with an label with blue instead of black writing. If you replaced a black labelled coin cassette, the new cassette may probably no longer fit in the old housing.</i></p>	<ul style="list-style-type: none"> Insert coin cassette correctly and let engage [Fig. 4] Replace housing

Status message	Possible causes	Remedy, hints
RETURN LEVER PRESSED	<ul style="list-style-type: none"> Return lever pressed Sensor in coin validator defective 	<ul style="list-style-type: none"> No error, if necessary, check vending machine return mechanism Contact service technician
INHIBITED BY VENDING MACHINE	Vending machine inhibits coin changer	Check vending machine, probably empty or defective
INHIBITED BY INTERNAL AUDIT MODULE	Coin acceptance inhibited during audit data reading	No error
REMOVE CASHLESS PAYMENT MEDIA	Vending machine returns card	No error
VEND ACTIVE	Vending operation in process	No error
FREE VEND BY MACHINE	BDV/Executive vending machine grants free vend	No error
CHECK CASHBOX SENSOR	CP3 sensor error	Error is compensated, in due time contact service technician for cleaning or replacement issue
ERROR IN THE SORTER PART	Coin inserted for too long covered sorting control as <ul style="list-style-type: none"> coins got stuck CP4 sensor defective 	<ul style="list-style-type: none"> Remove coin jam from sorter (cp. "Cleaning coin path in validation and sorting area (yearly)", p. 51) Contact service technician
COIN INHIBITED	Coin changer inhibits coin inserted	No error. If necessary, enable coin using menu or HENRI (cp. separate configuration manual)
LOW VOLTAGE DETECTED	Relevant to battery version	<ul style="list-style-type: none"> Check battery voltage Check vending machine
COIN REJECTED	Measured values of coin inserted beyond acceptance band	No error. If necessary, reinsert coin
TUBE CASSETTE REMOVED		No error
SORTER OPEN	Sorter cover <ul style="list-style-type: none"> not closed correctly open 	<ul style="list-style-type: none"> Let engage sorter cover correctly No error. Let engage cover correctly after having finished working
INVENTORY DISABLED BY VMC	Inventory keys inhibited	No error. If necessary, enable keys using menu or HENRI (cp. separate configuration manual)
RECYCLER CONNECTED		No error
CC TALK HOPPER INTERFACE CONNECTED		No error
BILL VALIDATOR CONNECTED		No error
CARD SYSTEM 1 CONNECTED		No error
CARD SYSTEM 2 CONNECTED		No error
AIRPORT SENDS SMS		No error
ACCOUNT CREATED, DATA STORED	Relevant to airport changers: Menu key has been pressed for at least 8s, the changer then stored internally all audit data for later readout	No error









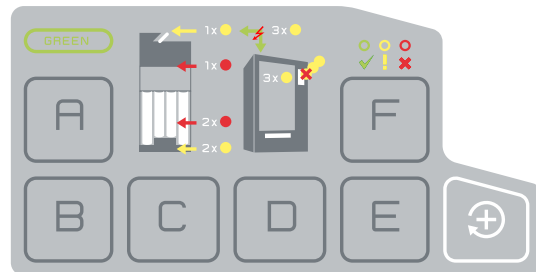

Quick diagnosis using status LEDs (only c² green)

If there is a fault on a c² green coin changer, the status LEDs at the top of the coin validator show where the fault is. In order to diagnose the cause of the fault in detail, please use the HENRI service tool (*cp. "c² status & error messages", p. 64*).

If the green LED lights up or flashes, there are no faults and the device is working properly. If the yellow LED flashes there is a definite fault which, in general, can be easily remedied. If the red LED flashes, it is probably a fault that must be remedied by a service technician.

The schematic representation of the c² green user interface may help in locating the fault.



Status LED	Possible causes	Remedy, hints
 lights up	Changer operational	No error
 flashes	Changer in tube filling mode	No error
 and  light up	Coin inserted inhibited from the machine/changer	<ul style="list-style-type: none"> Check vending machine settings, possible that high-value coins are inhibited because tubes are empty Enable coin using HENRI service tool (cp. configuration manual)
 flashes once	<ul style="list-style-type: none"> Return lever pressed permanently Sensor in coin validator defective 	<ul style="list-style-type: none"> No error, if necessary, check vending machine return mechanism Contact service technician
 flashes twice	<ul style="list-style-type: none"> Coin got stuck in payout area Payout disc got jammed Payout motor defective 	<ul style="list-style-type: none"> Remove coin cassette and then jammed coin. Reinsert cassette and pay out coin from relevant tube using inventory key. The error will be reset Remove coin cassette, dismount and reinsert disc. For this cp. "Cleaning payout sensor system", p. 52. If the coin cassette has been removed, the c² tries after 10s to turn the disc in final position again and resets the error Contact service technician or replace payout set
 flashes 3x	<ul style="list-style-type: none"> Changer inhibited by vending machine Changer inhibited by internal audit module 	<ul style="list-style-type: none"> Check vending machine, possibly empty or defective Acceptance limitation or highest price (with single vend) reached, if necessary, use HENRI service tool to correct (cp. configuration manual) Enable changer again using mobile data retrieval unit
 flashes once	<ul style="list-style-type: none"> Coin jam in coin validator Sensor error in coin validator 	<ul style="list-style-type: none"> Remove coin jam Contact service technician
 flashes twice	<ul style="list-style-type: none"> Error in coin changer's data memory Error in interface module 	<ul style="list-style-type: none"> Check and correct coin changer configuration in the SETTINGS menu, if necessary by means of the HENRI service tool Contact service technician
 flashes 3x	Vending machine no longer communicates with changer and has sent no command in 2s	Check vending machine control system and connecting cable

Diagnose-Menü

The diagnostic menu gives information about the coin changer's status or malfunctions. Each sub-assembly is monitored separately:







- Coin changer
- Interface module
- Payout module
- Motor position sensors
- Filling level sensors left/middle/right
- Audit module (option)
- Display/keyboard (option)

The sub-assemblies' operating state is displayed on an own diagnostic screen each.

Displaying diagnostic menu

Quick approach:

 = Main menu > **D** = Diagnostic > *Relevant coin changer module (sub-assembly)*

	Press key ...	How often?	Effect
1		1 x	You enter the main menu
2		1 x	You enter the DIAGNOSTICS menu
3		until <i>relevant changer module</i>	You want to enter a certain diagnostic screen
4		1 x	Now you can check the changer module on this screen (cp. "Diagnostic screens", p. 71)
5		1 x	You want to go back to the diagnostics menu
6	<i>Repeat steps 3–5 to check further changer modules, if necessary</i>		
7		1 x/2 x	You return to main menu/operating mode

Diagnostic screens

This section overviews the single diagnostic screens:

Coin validator

```
Software:
9200391-06.00
Serial Number:
01160241/10/0001
Datablock-No.:
EUR 0 002 001 00
MM: 02
Back: EXIT
```

Firmware version of the coin validator module
 Serial number
 Currency data block number
 Standard measurement mode, also possible: measurement mode adaptations for particular fraud coins

Fig. 15: Coin validator diagnostics OK

```
Software:
9200391-06.00
Serial Number:
01160241/10/0001
Datablock-No.:
EUR 0 002 001 00
MM: 02 Error
Details -->
```

Fig. 16: Press D-key for error details

Interface module (changer module)

```
Software:
C2 v6 F
9200377-03.09
Datablock-No.: C
EUR 05 014506 01
Status: OK
Back: EXIT
```

Firmware-dependent model number
 Firmware version of interface module
 Changed using HENRI SIM card config.
 Configuration data block number
 No error

Fig. 17: Interface module diagnostics OK

```
Software:
C2 v6 F
9200377-03.09
Datablock-No.: C
EUR 05 014506 01
Status: Error
Details -->
```

Fig. 18: Press D-key for error details

Payout module

```
Payout module
Status: OK
Back: EXIT
```

No error

Fig. 19: Payout module diagnostics OK

Audit module/airport (option)

```
Software:
9200388-03.07
60%
Status: OK 01
Airport present
and connected
Back: EXIT
```

Firmware version of audit module
 Option: Reception quality of airport antenna, >30% = OK, <30% reposition antenna
 01/05 = No error, 00 = not registered, 02 = searching net, 03 = registration refused
 Option: airport function set up

Fig. 20: Audit module diagnostics OK

```
Software:
9200388-03.07
0%
Status: Error03
Airport present
not connected
Back: EXIT
```

Fig. 21: Press D-key for error details

Display/keyboard (option)

```
Software:
9200381-01.00
Status: OK
Back: EXIT
```

Firmware version of user interface
 No error

Fig. 22: User interface diagnostics OK

Motor sensors

```
Motor sensors
L1 246 245
L2 238 252
M1 255 000
M2 255 000
R1 225 222
R2 216 214
Back: EXIT
```

Sensor values, position left motor, >100 = OK, <100 = cp. "Cleaning payout sensor system", p. 52
 Stored values for long-term compensation
 Sensor values, position middle motor, >100 = OK, <100 = cp. "Cleaning payout sensor system", p. 52
 Stored values for long-term compensation
 Sensor values, position right motor, >100 = OK, <100 = cp. "Cleaning payout sensor system", p. 52
 Stored values for long-term compensation

Fig. 23: Motor position sensor diagnostics OK

(Filling level) sensor left (tubes A&B)/middle (tubes C&D)/right (tubes E&F)

```
R   A   B
S4 186 186
S3 175 171
S3 177 173
S2 175 173
S1 171 123
Back: EXIT
```

Change tube
 Max. readings
 Full sensor readings, >50 = OK
 75% sensor readings, >50 = OK
 50% sensor readings, >50 = OK
 Empty sensor readings, >50 = OK
 Light beam interrupted (cassette removed?)
 D = diode/T = transistor defective, replace interface module

Fig. 24: Filling level sensor diagnostics OK

```
R   A   B
S4 181 181
S4 003 1 003 1
S3 000 T 000 T
S2 000 D 000 D
S1 001 1 000 1
Back: EXIT
```

Fig. 25: Diagnostics not OK



If the sensor values are lower than 50, you should observe them. If they are even lower than 30, the filling level optics might be soiled or defective (cp. "Cleaning filling level sensor system", p. 55).

11 Index

A

- Accentuations in the text 7
- Acceptance band, token
 - erase 34
 - narrow 26
 - wide 26
- A–F keys 12, 13
- Alternative coin value 30
- Attention 7
- Audit data
 - display 45
 - print 47
 - read out 46
 - structure 40
 - which data is collected? 40

C

- Cassette
 - cleaning filling level sensor system 55
 - empty 13
 - up to float level 14
 - fill
 - by inserting coins 15
 - direct filling 19
 - optimise stock 23
- Change
 - stock 11
 - optimise 23
- tubes
 - empty 13
 - empty, up to float-level 14
 - fill (by inserting coins) 15
 - fill (direct filling) 19
- Chapter summary 7
- Cleaning 51

Coin

- flow 23
 - group A/B for token 31
 - insert (tube filling) 15
 - management 23
 - path, cleaning 51
 - payout 11, 12, 13
 - stock in the tubes 11
 - value, alternative 30
- Coin cassette
 - cleaning filling level sensors 55
 - empty 13
 - up to float level 14
 - fill
 - by inserting coins 15
 - direct filling 19
 - optimise stock 23
 - Conventions, manual 7
 - Current version 38
 - cxb (filename extension) 36

D

- Danger 7
- Delete
 - statistical data 49
 - token configuration 34
- Diagnostics 70
- Dialogue language 10
- Discharge, electrostatic 9
- Display texts 8
- Disposal 7
- Documentation, additional 8
- dsp (filename extension) 36

E

- Electrostatic discharge 9
- Empty coin cassette 13
 - up to float level 14
- Environmental protection 7
- Error
 - correction 64, 70
 - message 64
 - using status LEDs (c2 green) 68

F

- Filename extension
 - cxb 36
 - dsp 36
 - mot 36
- File selection 38
- Fill coin cassette
 - by inserting coins 15
 - direct filling 19
- Filling
 - level sensor system, cleaning 55
 - mode 14, 16, 21
- Firmware version
 - current
 - download 36
 - load in HENRI 37
 - display 35
 - update 36, 39
 - install 38, 39
- Flash current firmware 36
- Float level
 - empty change tubes 14
 - fill change tubes 20
- Flow of money 24
- Freevend tokens 31
- FW versions 35

G

- General information
 - chapter 7
 - manual 7
 - menu language 10
 - short reference guide 7
- Guide, chapter summary 7

H

- HenriFlash 36
 - install 36
- HenriFlash.exe 36

I

- Infrared
 - adapter 46
 - interface 46
- Instructions, additional 8
- Introduction
 - chapter 7
 - manual 7
 - menu language 10
- Inventory 11
 - keys 11, 12, 13

K

- Keys 8
 - A–F 12, 13

L

- Language 10
- LEDs, diagnostics 68

M

- Machine number, display 41
- Maintenance 51
- Malfunction correction 64, 70
- Manual conventions 7
- Manuals, additional 8
- Markings in the text 7
- Menu
 - items 8
 - language 10
 - texts 8
- mot (filename extension) 36

N

New version 38
Notes 7

O

Operating instructions, additional 8
Optical adapter 46

P

Payout
 of tube coins 11, 12, 13
 set sensors, cleaning 52
Pictograms in the text 7
Print audit data 47
Printer
 operation 47
 settings 47
Proposals for optimisation 25

R

Readout of
 audit data 46
 statistical data 48
Reject Token function 33
Requests to perform an action 8
Return chute, redirect token 33
Runway, cleaning 51

S

Safety instructions 7
Second currency 30
Sensor system
 payout set 52
 tube filling level 55
Short reference guides, additional 8
Software version
 current
 download 36
 install 38, 39
 load in HENRI 37
 display 35
 update 36, 39
Sorting area, cleaning 51
Start button, printer 47

Statistical data

 erase from HENRI memory 49
 read out 48

Status

 LEDs, diagnostics 68
 message 64
 using status LEDs (c2 green) 68
 of analysis 25

Summary, chapter 7

Symbols in the text 7

T

Teach tokens 26

Text conventions 7

Token

 assigning coin group A/B 31
 audit data 41
 erase 34
 for payment/free vend 28
 return to the customer 33
 teach 26
 value 29, 30

Troubleshooting 64

Tube

 coins, optimise stock 23
 filling level 17, 22

Tubes

 cleaning filling level sensors 55
 empty 13
 up to float level 14
 fill
 by inserting coins 15
 direct filling 19
 optimise stock 23

U

Update menu 35

V

Value token 28, 30

W

Warning 7, 64
 using status LEDs (c2 green) 68