

Fig. 1

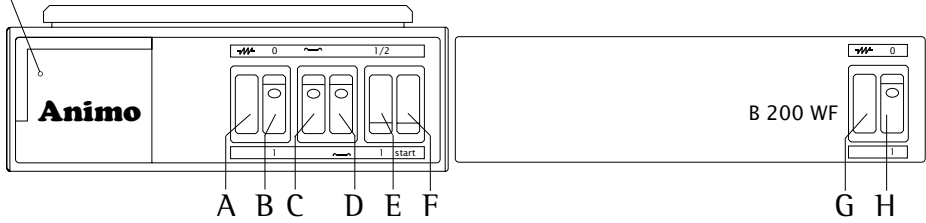

Fig. 2

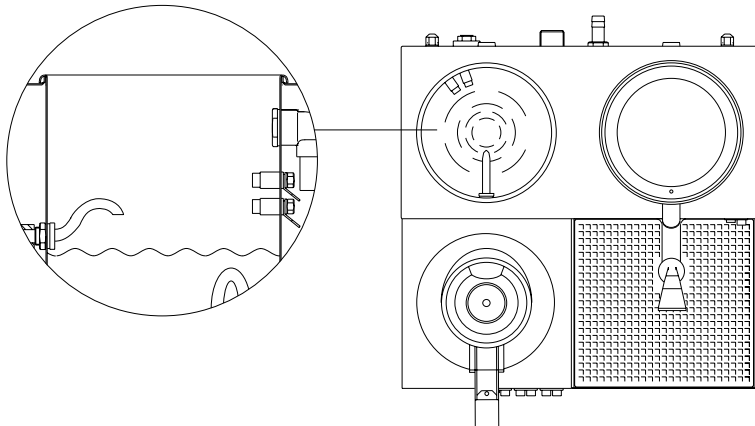

Fig. 3

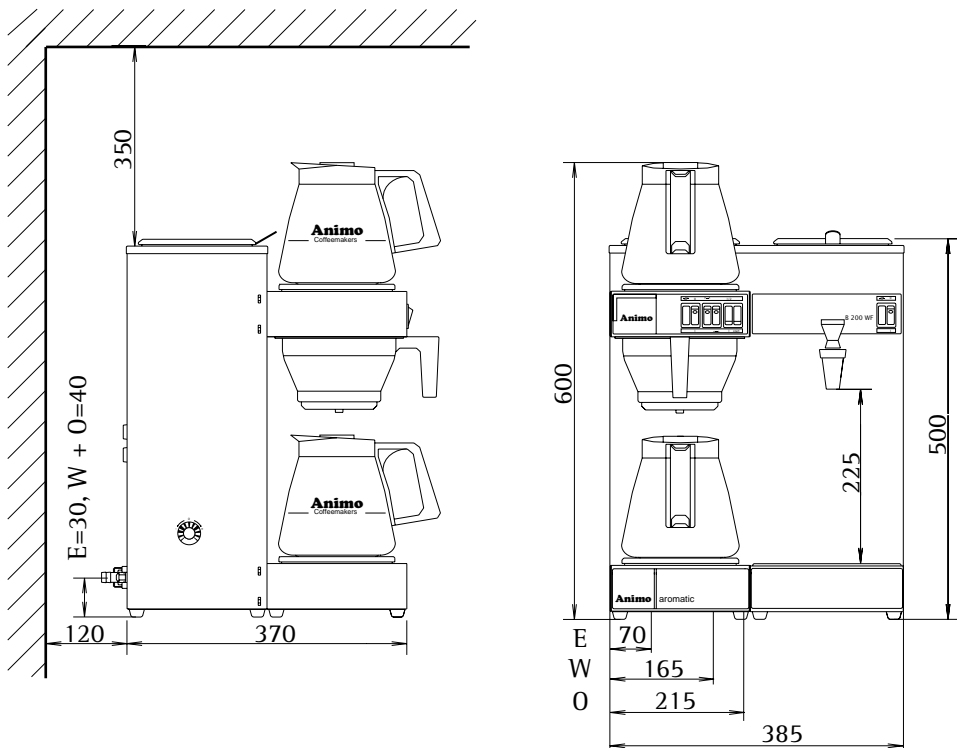

Fig. 4

E = Electriciteitaansluiting	W = Wateraansluiting	O = Overloopaansluiting
Electrical supply	Water supply	Overflow connection
Stromschnur	Wasseranschluß	Wasserablauf
Branchement électrique	Branchement d'eau froid	Branchement trop-plein



Dit apparaat voldoet aan de EMC-richtlijn 89/336/EEG, 92/31/EEG en de laagspanningsrichtlijn 73/23/EEG.

This appliance is in accordance with the EMC-Directive 89/336/EEC, 92/31/EEC and the low voltage directive 73/23/EEC.

Dieses Gerät wurde in Übereinstimmung gemäß EMV-Richtlinie 89/336/EWG, 92/31/EWG und Niederspannung-Richtlinie 73/23/EWG gebaut.

Cet appareil est conforme à la directive d'EMC 89/336/CEE, 92/31/CEE et à la directive de basse tension 73/23/CEE.

Animo behoudt zich het recht voor om onderdelen op elk gewenst moment te wijzigen, zonder voorafgaande of directe kennisgeving aan de afnemer. De inhoud van deze handleiding kan eveneens gewijzigd worden zonder voorafgaande waarschuwing. Deze handleiding is geldig voor de machine in standaarduitvoering. Animo kan derhalve niet aansprakelijk worden gesteld voor eventuele schade voortvloeiende uit van de standaard uitvoering afwijkende specificaties van de aan u geleverde machine. Voor informatie betreffende afstelling, onderhoudswerkzaamheden of reparaties waarin deze handleiding niet voorziet, wordt u verzocht contact op te nemen met de technische dienst van uw leverancier. Deze handleiding is met alle mogelijke zorg samengesteld, maar Animo kan geen verantwoording op zich nemen voor eventuele fouten in dit boek of de gevolgen daarvan.

Animo has the right to change parts of the machine at any time without advice or direct announcements to the client. The contents of this manual can also be changed without any announcements. This manual is to be used for the standard model/type of the machine. Thus Animo cannot be held responsible for any damage resulting from the application of this manual to the version delivered to you. For extra information on adjustments maintenance and repair, contact the technical department of your supplier. This manual has been written very carefully. However, Animo cannot be held responsible neither for mistakes in the book nor for their consequences.

Animo behält sich das Recht vor, Einzelteile ohne vorherige Bekanntgabe an den Kunden zu ändern. Der Inhalt dieser Anleitung kann ebenfalls ohne vorherige Bekanntgabe geändert werden. Diese Anleitung gilt für die Standardausführung der Maschine. Animo haftet daher nicht für Informationen über Einstellungen, Wartungsarbeiten oder Reparaturen, die nicht in dieser Anleitung enthalten sind. Wenden Sie sich bitte gegebenenfalls an den Kundendienst Ihres Händlers. Diese Anleitung wurde mit größtmöglicher Sorgfalt zusammengestellt. Animo haftet jedoch nicht für etwaige Fehler in dieser Anleitung oder für die Folgen solcher Fehler.

Animo se réserve le droit de modifier les pièces à n'importe quel instant, sans avis préalable et sans obligation de notification au client. Le contenu de ce manuel est également sujet à modification sans avis préalable. Ce manuel s'applique au modèle standard de la machine. Par conséquent, Animo n'est pas responsable pour les dommages éventuels découlant de l'application de ce manuel aux modèles non standard. Pour les renseignements sur certains réglages, les travaux d'entretien ou réparations qui ne seraient pas traités dans ce manuel, Animo ne peut être tenu responsable des erreurs éventuelles ni des dommages qui en découleraient.

GB

TABLE OF CONTENTS

1.	GENERAL DESCRIPTION	2
2.	TECHNICAL DETAILS	2
3.	INSTALLATION	3
3.1	Placing the B200WF	3
3.2	Connection to the water supply system and drain outlet	3
3.3	Connection to the electricity supply system	3
4.	CONTROL PANEL (FIG.2)	4
5.	PREPARATION BEFORE USE	4
6.	OPERATION	5
6.1	Making coffee	5
6.1.1	Quantity adjustment	5
6.2	Drawing off hot water	5
7.	MAINTENANCE	6
7.1	Cleaning (daily)	6
7.1.1	Removal of coffee deposits	6
7.2	Descaling (periodical)	6
7.2.1	Remove loose scale vesidue	6
7.2.2	Remove other scale deposits	7
8.	TEMPERATURE PROTECTION	7
9.	TRANSPORT	7

This instructions was designed for users of the Animo These operating instructions should be read carefully to ensure that your coffee machine is operated correctly and safely.

1. GENERAL DESCRIPTION

The Aromatic B200WF is an automatic machine to make coffee with a water storage heater and with a connection to a water tap. The machine is particularly suitable in areas with hard water due to the sophisticated construction of the water storage reservoir. The machine has a coffee machine and a separate water storage heater with a draining tap. This water storage heater can be used to serve tea, cacao, instant soup etc. ...

Through the appliance of a priority selection circuit, both the coffee machine and the water storage heater have a large capacity.

In figure 1 the main part are indicated.

In figure 2 the controls are indicated.

Figure 1:

A - Lower hot plate	I - Hot water draining tap
B - Glass jug	J - Drip tray with grid
C - Quantity adjustment (coffee)	K - Reservoir draining tap
D - Basket filter 90/250	L - Dry-boil safety guard
E - Control panel	M - Overflow connection
F - Upper hot plate	N - Water connection
G - Water reservoir coffee unit	O - Electrical supply
H - Water reservoir hot water unit	

The machine is supplied with the following parts:

- Basket filter 2x (art.no. 08635)
- Glass jug + cover 2x (art.no. 08208)
- Drip tray with grid
- Approx 50x paper coffee filters 90/250 (1000 pieces art.no. 01088)
- 2 sachets coffee fur remover (48 sachets at 10 gram art.no. 49007)
- 2 sachets descaling solvent (100 sachets at 50 gram art.nro 49009)
- Draining key
- Water supply hoses of 1.5 m
- Operation manual
- Coffee measurecup

2. TECHNICAL DATA

Type	: B 200 WF
Approx hourly capacity coffee	: ±13 L/h
Heating up period of coffee unit	: ± 5 min.
Coffee preparation time	: ± 8 min.
Minimum amount of coffee	: 1/2 jug
Paper filter size	: 90/250
Hourly capacity hot water (ca)	: ca. 20 L/h
Heating up period of hot water unit (15-98°C)	: ca. 7 min.
Maximal water drain	: ca. 1.5 L
Recover time after max. drain	: ca 3.5 min
Drawing speed	: 1.6L/30 sec.
Temperature and level detection	: electronic
Lenght of electric cable	: 1.4 mtr.
Water supply	: swivel 3/4"
Min. - Max. water pressure	: 1.5 - 8 bar
Flow pressure	: 1.5 L/min.
Dimensions	: see fig. 4
Empty weight	: ca. 16 kg

Technical alterations are reserved

Power supply (50/60 Hz)	Capacity	Fuse
220 V 1 phase/Neutral	2550 W	16 A
230 V 1 phase/Neutral	2800 W	16 A
240 V 1 phase/Neutral	3050 W	13 A

WARNING

- * Always remove the plug from the socket if the machine has been opened for repair or maintenance.
- * Do not position the machine in areas where the temperature drops below freezing point because there is always water left in the system.
- * Always plug the machine into an earthed wall socket.
- * Do not submerge or spray the machine.
- * Have all repairs carried out by a specially trained technician.
- * Make sure that the mains cable does not come into contact with the hot plates
- * If the machine is not used it is advisable to remove the plug from the socket and turn off the water tap.
- * Connect overflow tap to drainage tube.
- * Always observe local rules while installing the unit and use approved materials and parts.

3. INSTALLATION

Follow the instructions to place and connect the unit, specified below.

3.1 Placing the B200WF

Place the unit:

- at counter level and on a solid flat surface.
- where it can be connected to the water outlet and the electricity grid.
- Such that it is not causing any damage in case of leakage.
- Such that the ventilation holes in the back of the appliance are not blocked.

3.2 Connection to the water supply system drain outlet

- The B200 WF requires a water stop valve to be near the machine.
- Connect the water hose provided to the cold water supply and the water connection on the back of the unit. The hose has a length of 1.5 m.
- Connect the overflow connection in open connection with a drain (syphon) in such a way that the excess water can be drained in case of a malfunction or maintenance.

3.3 Connection to the electricity supply system

Depending on the model, the appliance should be connected according to the instructions in the figures below.

- (fig.5) In case of 220V-240V 1 phase with fitting connection.
- (fig.5) In case of 220V-240V 1 phase (3-core cable).

The following remarks apply to figure 5:

- If the plug fitted on the machine cable does not fit to your socket, replace it with a new plug that does fit.
- The replaced plug should be disposed of as it can be dangerous if plugged in a socket.

The following points should be observed when wiring a new plug:

1. The green/yellow-coloured wire ("EARTH") should be connected to the terminal which is either marked with the letter "E", the "earth" symbol (\perp) or coloured green or green/yellow.
2. The blue-coloured wire ("NEUTRAL") should be connected to the terminal which is either marked with the letter "N" or coloured black.

- The brown-coloured wire ("LIVE") should be connected to the terminal which is either marked with the letter "L" or coloured brown.

IMPORTANT!

The 3 core main cable (fig. 5) has the following wiring code:

Green/yellow - Earth
Blue - Neutral
Brown - Live

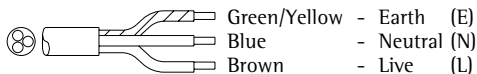

fig. 5

4. CONTROL PANEL (FIG. 2)

A - Selection switch for full / half full jug

B - Start switch to make coffee

C - On / off switch of upper hot plate

D - On / off switch of lower hot plate

E - Indicator lamp of coffee unit

F - On / off switch of coffee unit (main)

G - Indicator lamp of hot water unit

H - On / off switch of hot water unit

5. PREPARATIONS BEFORE USE

The following procedure should be carried out before a new appliance is used.

- Open the manually operated water stop valve and check that the swivel connections are not leaking.
- Place the drip tray in front of the water storage heater
- Slide the basket filter into the machine and place an empty jug under the filter.
- Remove the covers of the water reservoir, fill the left reservoir up to the syphon (fig. 3), fill the right reservoir just as full as the left reservoir.
- Put the plug fitting in the socket and switch the coffee unit and the hot water unit on (fig. 2F and 2H). The indicator lamp (fig. 2C) of the coffee unit will burn. **MIND!** The unit has a preference selection switch. This means that the heating of the coffee unit is given priority over the heating and refill process of the hot water unit.
- The water in the coffee machine reaches its correct temperature after 5 minutes. The indicator light will go off. Then the water storage heater will start to heaten up.
- Select full jug with the selection switch (fig. 2A) and press the start switch (fig. 2B). The jug will now be filled with hot water.
- A signal will sound ca. 1 minute after the hot water has been produced. This means that the brewing process has finished. Empty the jug when the filter is drained.
- After using the coffee machine, the hot water unit starts heating. After about 7 minutes the water has reached its temperature the indication light will go off (fig. 2G).
- Drain two jugs of hot water with the hot water tap.
- Now the unit is ready for use.

6. OPERATION

- ◇ Making coffee, see section 6.1.
- ◇ Quantity adjustment, see section 6.1.1.
- ◇ Drawing off hot water, see section 6.2.

Basic rules for making coffee

Use extra -fine grind coffee (± 40 gram/litre)

Keep the jugs and the basket filters clean.

TIP! Store some extra basket filterpapers in the extra basket filter or place in this filter already a basketpaper filter and coffee.

Then it will be easy to make a next brew, without losing much time.

6.1 Making coffee

1. Place a basket filterpaper (90/250) with an appropriate amount of coffee (extra-fine grind) in the basket filter. The quantity can be measured with the provided measurecup glass. Commonly this is 70-80 gram for 1.8 l.
2. Place a clean empty jug under the filter. Switch the lower hot plate on (fig. 2D).
3. Switch the coffee unit and the hot water unit on (fig. 2F and 2H). The indicator light of the coffee unit will now burn.
4. Select a full jug with the selection switch (fig. 2A) and press the start switch (fig. 2B). The unit will now start brewing. **MIND!** When the coffee unit has just recently been switched on, then the brewing making of coffee will begin only once the water in the reservoir has reached the right temperature.
5. After 5-6 minutes a signal will sound to indicate that the coffee is ready
6. Slightly stir the coffee in the jug and pour it out, or store it on the upper hot plate. The upper hot plate can be switched on with the switch (fig. 2C).
7. After cleaning the basket filter the machine is ready for the next brew.

6.1.1 Quantity adjustment

If the quantity of coffee is insufficient during operation, this can be caused by the quantity of coffee, by the kind of grind used or the hardness of the water.

This is how the quantity of water can be set. The setting can be found on the left side of the unit. Use a small screwdriver.

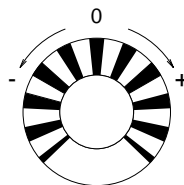

1. Only take one step a time. To increase turn to the right, to decrease turn to the left.
2. Check the quantity of hot water after each adjustment. Keep in mind that 5

to 10% of the water remains in the ground coffee.

6.2 Drawing off hot water

MIND! The hot water unit can only be switched on when the coffee unit is switched on.

1. Switch the hot water unit on (fig. 2H). The indication lamp will light up.
2. After ca. 7 minutes the water has reached its temperature and the indication light will go off. Hot water can now be tapped from the hot water tap. (fig. 11)

Achievements of this water storage heater?

- Draw off a maximum of, 1.5 litre hot water each time. It takes ca. 7 minutes before temperature has been restored (when no coffee is being made).
- When the indication light (fig. 2G) goes out, more hot water can be drawn off.

MIND!

- The hot water unit is switched off when the coffee-making reservoir is being heated. Hot water can be drawn off, but the hot water unit will only be refilled, when the heating of the coffee-making reservoir is finished.
- When the coffee unit is switched off, the hot water unit will switch off also. This is perfectly normal. When only coffee is being made, the hot water unit can be switched off with the switch (fig. 2H).

WARNING 

- Do not leave the unit during maintenance.
- Always follow the prescriptions, that are delivered with the used descaling solvent.
- It is advisable to wear protecting glasses and gloves during descaling.
- After descaling, run the appliance through at least three cycles.
- Wash hands after descaling.
- Do not submerge or hose the unit.
- Have all repairs fixed by an authorised technician.

7. MAINTENANCE

- ◇ For the cleaning of various parts, see section 7.1.
- ◇ Removal of coffee deposits, see section 7.1.1.
- ◇ For descaling the unit, see section 7.2.
- ◇ To remove loose scale, see section 7.2.1.
- ◇ To remove other scale formations, see section 7.2.2.

7.1 Cleaning (daily)

- Clean the unit with a clean moist cloth.
- Avoid using abrasive. It can cause scratches and dim spots. The sliding filter and the drip tray can be washed normally.
CAUTION! The sliding filter must not be machine washed.

7.1.1 Removal of coffee deposits

A sachet of coffee deposit solvent is supplied with the unit. Usage is extremely simple.

1. Take a bowl filled with ca. 5 - 10 litre warm water and dissolve the coffee deposit solvent from the sachet into it.
2. Put the parts that need to be cleaned in the bowl and soak them for 15 to 30 minutes.
3. Rinse several times with warm water. Repeat treatment if the result is insufficient.
4. Scatter coffee deposit solvent on very filthy spots and clean with a wet brush.

7.2 Descaling (periodical)

During operation scale will form in the unit. Therefore the unit needs to be descaled regularly to guarantee the lowest energy consumption and proper functioning.

When to descale?

- Dependent on the frequency of usage and the hardness of the water, we advise to inspect the unit visually regularly for scale formation.
- Remove the covers of the reservoir regularly; If there is loose scale grit on the bottom, or if there is severe scale formation on the walls, then the unit needs descaling.
- In some cases it is sufficient to remove loose scale grid.

It is advised to descale the coffee-making reservoir and the water storage heater at the same time.

7.2.1 Remove loose scale residue

1. Switch off the unit and remove the plug from the wallsocket.
2. Close the water output tap and detach the hose supply.
3. Remove the covers from the reservoirs.
4. Check if the overflow is connected to a suitable drain. Open the taps on the backside of the unit (fig. 1N) with the provided drawing key. Water from both reservoirs will now be drawn off. Close both taps when the reservoirs are almost empty.
5. Take the overflow connection (fig. 1M) off and turn the unit upside down over the sink. Loose scale grid will then come out. Rinse the reservoirs with water to take the scale grids out further.
6. When there is no more scale in the unit, it can be operated as usual. Consult section 3.2 "Connection to the water supply system and drain outlet" and section 5 "Preparation before use".
7. When there remains some scale on the heating element, the unit can be taken into use. Consult section 3.2 "Connection to the water supply system and drain outlet" and section 5 "Preparation before use". Then go on as described in section 7.2.2.

7.2.2 Remove other scale deposits

To remove remaining scale formation use ANIMO descaling solvent.

1. Carefully read the caution notice and the directions on the sachet ANIMO descaling solvent.
2. Dissolve 2 sachets of 50 gram ANIMO descaling solvent into 2 litre of warm water.
3. Slide an empty basket filter in the machine and place an empty jug under the filter.
4. Switch the unit on of using the on / off switches (fig. 2F and 2H).
5. Check if the overflow is draining on an draining outlet and open the taps on the back of the unit with the provided keys (fig. 1K). Close both taps when the reservoirs are half empty.
6. Share the acid solution among both reservoir.
7. Switch the unit on with the on / off switches (fig. 2F and 2H).
8. Let the solution affect for ca. 10. minutes. Spread the acid regular with a brush over the scaled parts in the reservoir.
9. Tap some of the acid from the hot water tap and pour it back into the right reservoir immediately.
10. Select a full jug with the selection switch and press the start switch (fig. 2B). The water reservoir will fill and the acid leaves the reservoir through the overflow.
11. When still scale is visible in the reservoir, repeat steps 2 to 10. Once all scale is gone, resume with step 12.
12. Open the taps on the back of the unit with the supplied keys (fig. 1K). Drain the reservoir completely and close the taps again.
13. Resume normal operation of the unit according to section 5. Flush the coffee machine at least three times.
CAUTION! Don't for get to empty the jug under the basket filter when it is almost full. Tap at least three full jugs from the hot water unit.

8. TEMPERATURE PROTECTION

There are two temperature protections in the unit that can be accessed from the outside. These are at the back of the unit (fig. 1L).

The protection on the left belongs to the water storage heater, the one on the right belongs to the coffee machine. These protections switch off the corresponding parts when the temperatures rise too high. The most common cause for switching off is scale that has not been removed in time.

If the temperature protection operates proceed as follows:

1. Let the unit cool down.
2. Unscrew the black protection cover.
3. Push the button, that now appears and replace the black cover and tightly.

When the protection was triggered due to scale formation, then proceed according to section 7.2.2. When the cause was not in scale formation, then contact your dealer.

9. TRANSPORT

Proceed as followed to transport the unit:

1. Switch the unit off and remove the plug from the wallsocket.
2. Close the water outlet tap and disconnect the supply hose.
3. Remove jugs, the basket filter, the drip tray and the covers of the reservoirs.
4. Open the taps at the back of the unit (fig. 1K) with the supplied key. Drain the reservoirs completely. Close the taps again.
5. Disconnect the overflow drain.
6. Turn the unit upside down to let the remaining water out over the sink.
7. Replace the parts, mentioned in point 3.
8. The unit is now ready for transportation.
9. Proceed with section 3 "Installation" to reinstall the unit.

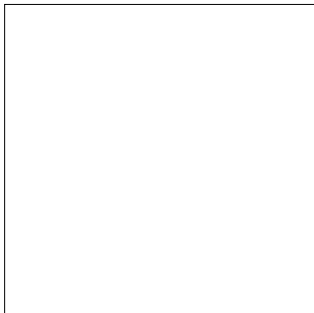
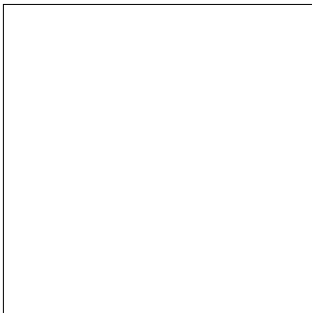
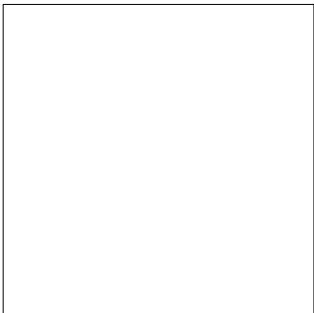
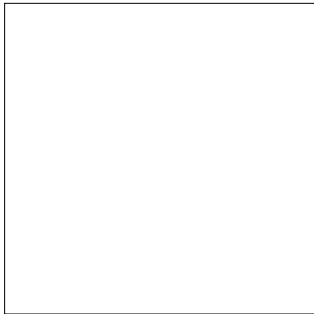
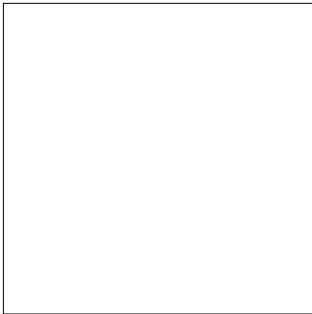
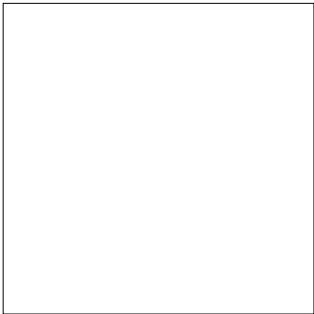
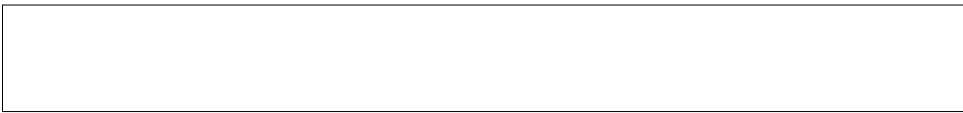

Animo B.V. Headoffice
Dr. A.F. Philipsweg 47
P.O. Box 71
9400 AB Assen
The Netherlands
Tel. no. +31 (0)592 376376
Fax no. +31 (0)592 341751
E-mail: info@animo.nl
Internet: <http://www.animo.nl>

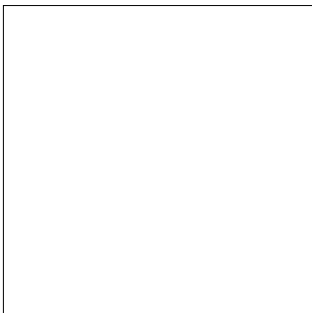

0498 Rev. 1 150999 **Animo** 09983



Accredited by
the Dutch Council
for Certification

